

NC Baptist Men

RAMP Construction 101

A “how to” manual for handicap ramp construction

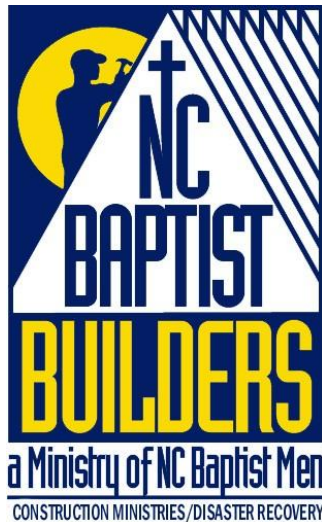

Chapter 4	<i>The Pre-Build</i>	
	The pre-build	4-1
	Let's get building	4-1
	Building your modules	4-2
	Building the rest landing	4-3
	Building the turn-around landing	4-3
	Girders	4-3
	Ramp Module	4-4
	Rest Module	4-5
	Top Landing Module	4-6
	Rest Landing	4-7
	Turn Around Landing	4-8
	Terminal Wedge Module	4-9
	180 degree landing detail	4-10
	90 degree landing detail	4-11
Chapter 5	<i>At the Ramp Site</i>	
	At the ramp site	5-1
	Now let's get to work	5-2
	Top landing	5-2
	First Module	5-3
	Rest landing	5-4
	Terminal module	5-5
	Cutting Your Post	5-5
	Top Rail	5-6
	Handrails	
	Module 1	5-7
	Module 2	5-8
	Module 3	5-9
	Decking board diagram	5-10
	Top Rail continued	5-11; 5-12
	Handrail module 4	5-13
	Lateral Bracing	5-14
	Decking and handrail figures	5-15; 5-16
Appendix A	<i>Definitions</i>	
	Total Drop	A-1
	Rest Landing	A-1
	Top Landing	A-1
	End Point	A-1
	Terminal Module or Wedge	A-1

Appendix B	<i>Consultation Form</i>	
	Checklist	B-1
	Ramp configurations	B-1
	Cost Estimates	B-1
	Requirements of Building Permit	B-1
	Permit Application	B-1
	Site Plan	B-1; B-2
	Cost Estimates	B-3
	Building inspectors requirements	B-4
Appendix C	<i>County/City Regulations</i>	
	The Building Permit Process	C-1
	Building codes	C-2

Nov 1, 2011

Preface

What greater pain can a person feel who is disabled and in a wheelchair, either from a debilitating disease or due to an unfortunate accident, than to be entrapped in their own home. As a lady told us before we built her ramp, "I feel like a prisoner in my own home". Her husband was not physically able to get her from the house into the car and had to call the local rescue squad for them to send help each day when it was time for him to carry her for her daily radiation treatments. When they got home he would have to call the rescue squad to get her from the car back into the house. Another lady who we built a ramp for had to visit her husband in the rest home when she could. He had a severe stroke which left him unable to walk and confined to a wheelchair. She could not bring him home because she could not get him in and out of their mobile home.

There are people in your community who may be facing these same circumstances. There are men in your church or other community groups who have the skills and experience to provide a remedy to families like these. In my church this ministry has involved men from age 30 to 80. We have younger men who still work a public job and who can help at night during the pre-build stage, and then older men, some who have retired who can work not only during the pre-build but also at the site when we assemble the ramp.

A wheelchair ramp ministry is a great way for you to minister to people who may be facing one of the lowest valleys they have ever had to face in their life. A wheelchair ramp ministry is a great way to gather the men of your church or group so they can enjoy each other's company and pool the talents and skills together in a way that will help their fellow man. You involve yourself in work like this for the purpose of blessing someone else and you end up being just as blessed yourself. There is no greater feeling than after completing a ramp and seeing the joy in the face of the person in the chair and their family member as they gain part of their freedom back, and knowing that God allowed you to be a part of this.

It is my desire that many people in your community will find this freedom as you use this manual to develop a wheelchair ramp ministry. The following steps are just some suggested steps in not only how to build a wheelchair ramp but how to do it as a ministry project. In addition to the material or logistical steps needed to be done during the initial consultation the ministry aspect of what you do is even more important.

Chapter 1

Why a Handicap Ministry?

Why a Handicap Ministry?

1. It mirrors the example Jesus gives us in scripture. Meeting a person's physical need as a means of opening the door to address their spiritual needs.
2. It meets the need of the handicap family member and other family members who are their primary caregivers. If the handicapped person is confined to a nursing home because the family can not physically get them into and out of their home, all members suffer.
3. It is not a ministry that meets just a current time need. As our population continues to age, this ministry will be forever more needed.
4. It is a ministry that many age groups can be involved in.
5. It does not require a great deal of money to get started.
6. There is not a lot of upfront cost. All the tools that are needed are already owned by someone in your group.
7. It is a ministry that reaches beyond the walls of our church. A service that not only is offered to our own members but to non members as well.
8. It is a renewable commodity. The ramps are built so that they can be disassembled and used elsewhere.
9. It is visible to others in the community which may open other doors to share the Gospel.
10. You will as blessed as the person you build the ramp for.

Why do we give of our time and energy to meet the physical needs of others? One only has to go to the Book of Mathews beginning with chapter eight to see how many people Jesus gave His time and energy to meet the needs of. Who but He is a better example of how concerned we should be of other people's needs:

- Mathew 8:3..... Jesus cleansed the Leper
- Mathew 8:13..... Jesus healed the Centurion's servant
- Mathew 8:15..... Jesus healed the fever of Peter's mother in law.
- Mathew 8:16..... Jesus healed many who were demon-possessed and sick.
- Mathew 8:28..... Jesus cast out the demon in 2 men in a cemetery. The demons were allowed to enter a Herd of pigs that then drowned.
- Mathew 9:2..... Jesus healed a paralytic lying on a bed.
- Mathew 9: 20-25..... Jesus healed a woman with a blood disease who touched the hem of His garment as he was on His way to raise a ruler's daughter from the dead.
- Mathew 9:29..... Jesus healed 2 blind men.
- Mathew 9:32..... Jesus healed a mute, demon-possessed man.
- Mathew 9:35..... Jesus went about the cities and villages healing every sickness and every disease.
- Mathew 10:8..... Jesus commanded His disciples to heal the sick, cleanse the lepers, raise the dead, and cast out demons.
- Mathew 11:28..... Jesus said "Come to me all you who labor and are heavy laden, and I will give you rest.
- Mathew 12:13..... Jesus healed a man with a withered hand.
- Mathew 12:22..... Jesus healed a demon-possessed, blind, and mute man.
- Mathew 14:14..... Jesus was moved with compassion for them and healed their sick.
- Mathew 14:19..... Jesus fed the 5,000 with 5 loaves and 2 fish.
- Mathew 14:31..... Jesus pulls Peter up out of the water.
- Mathew 14:36..... Jesus healed many who touched His garment.
- Mathew 15:28..... Jesus healed the daughter of the women from Canaan.
- Mathew 15:30..... Jesus healed many who were lame, blind, mute, and maimed.
- Mathew 15:36..... Jesus fed the multitude with seven loaves and a few fish.
- Mathew 17:18..... Jesus healed an epileptic boy.
- Mathew 20:34..... Jesus healed 2 blind men as He left Jericho.
- Mathew 21:14..... Jesus healed the blind and lame in the temple.
- Luke 22:51..... Jesus even healed the soldier's ear when one of the disciples cut it off with a sword.

NC Baptist Men Logo....Serve in Christ's Spirit



Chapter 2

Initial Home Visit

1. The initial consultation with family

The first thing you want to get a feel for is how the disability is limiting the person's mobility. Is the condition that made the wheelchair necessary a temporary or more permanent condition? Will the wheelchair ramp also help with other family members, such as elderly parents or grandparents who visit the home? I have seen circumstances where the individual had to stay in a rest home because the wife could not physically get the husband in and out of home without a ramp, and another case where the husband was having to call the local volunteer rescue squad for help to get his wife in car for him to carry her to daily radiation treatments and call them back again to get her back in house after getting back home. This lady made the comment she felt like a prisoner in her own home because once she was back in the house she had to stay there until help was called the next day when it was time for her next treatment.

2. Tell them why your group does what it does

This is a good time to inject a little about your Men's Ministry. Your men volunteer their busy time and God given talent to demonstrate His love for us through their sharing this love with them. It is a good time to circle up any guys with you and the family and have prayer praying that God will touch the person in the wheelchair in a special way. That God would heal them if it be His will. Pray that God will bless the efforts of your men and they will bring a blessing to this home. Thank Him for the family that stands by this person during this season that they need help. Pray that His will be done in this project and that He get any glory that comes from this effort.

3. Who is paying for the materials?

You may already know if the family is paying for the materials or are they being provided by you or someone else. Provided in this material is an estimate of how much each part of a typical ramp might cost (See page 13 of Appendix B) so if cost is a part of your discussion when meeting with family, you can give them some idea of the cost involved. There is also an Excel Worksheet provided that could be used on a laptop that with just a few numbers entered in can give you an even closer estimate of the total cost. If you know that your group is paying for the materials you may want to discuss with the family that the only thing you normally ask is that if the ramp is ever not needed in the future that they will call you and your men can come and remove the ramp and be able to use it for another family that needs help. You may want to consider coming up with some type of little metal plate with your contact information and a unique number assigned to each ramp on it, in the event the family needs to contact you in the future for removal of the ramp or for repairs or adjustment to the ramp.

Keeping a log of this Ramp number and information about ramp could also be useful to your group as the number of ramps you have built over a period of years becomes harder to keep track of. (Note: The modules and landings outlined here are built in such a manner that they can easily be disassembled to a point making them reusable.)

4. When a plan comes together

Now to move toward coming up with your plan: Look at layout of home and determine with homeowner the most logical door that wheelchair would need to come in and out of the home. It would do little good to build a ramp at a door that has an unmovable obstacle inside the house such as a narrow door or tight corner. A good thing to consider also is the hopefully unlikely event that rescue personnel would need to get the disabled person out of house on a stretcher. Once you have considered the pros and cons from the inside of home for door that seems to be the best location for the ramp, you have to consider what obstacles you may face on the outside getting a ramp from the door to the end point. Let me inject the first definition here since it is critical to this step. The END POINT is the exact point at which the ramp will meet the ground. This needs to be at a place that is most convenient or desired to get the wheelchair on the ground. Most times this will be at the driveway. Then looking from the End Point back to the door where ramp will start, what unmovable obstacles stand in the way. You can always move a bush or cut down a small tree, but you don't want to move a pump house or a carport. If your path from End Point to door proves to be unobstructed you can move on to step 5.

5. Ramp Plan

The first step here is to determine your TOTAL DROP. Total Drop is the distance in inches of vertical drop from the bottom of the door or from an existing porch to which the ramp will be attached, to the ground at your end point. Determining this is crucial to the whole design of the ramp. To determine this Total Drop you can use a stake driven in ground or held by an assistant at your End Point that is long enough so that the top of stake is a point level or higher than the point at the bottom of your door or the porch where your ramp will begin. You now need a carpenter's line and a line level. Tack the end of your line at bottom of door or porch and extend line out to your End Point stake. Get your line level and mark where your line meets your stake. Measuring from your mark which is level with your door or porch down to the ground, you get your TOTAL DROP. Getting your Total Drop with this method also compensates for changes in ground elevation between your starting point and End Point. With the recommended drop of 1:12, meaning a drop of 1 inch for every 12 inches of run, or 1 foot of ramp for every inch in your Total Drop.

If your Total Drop is 24 inches, you will need 24 feet of ramp. If you are using a slope less than a 1:12, such as 1:16, then the feet of ramp you will need is more. See the chart below. It is recommended for every 20 feet of ramp you figure in a REST LANDING. A Rest Landing is a flat platform that is a minimum of 5 feet in length somewhere in the middle of a straight run of ramp or as a pivot point when you are changing directions, that gives the person in wheelchair or the person pushing the wheelchair a flat place to rest along the way up or down the ramp. When the Rest Landing is used to change directions such as in an Elbow Style Ramp the Landing must be at a minimum of 5 feet x 5 feet in size. In this example where our Total Drop is 24 inches. Your design might be a 12 foot ramp module, then a 5 foot Rest Landing, and then another 12 foot ramp module which gets you down to the ground at your End Point. While we are here at the End Point you will need to consider in your ramp plan an ending wedge module of a minimum of 3 feet that will get you down from the last module to the ground level at your End Point so their chair will roll off end of ramp onto ground without a big bump.

Using a 1:16 Grade

8 Foot Module will drop 6 inches

10 Foot Module will drop 7 1/2 inches

12 Foot Module will drop 9 inches

6. Ramp Configuration

With your door decided on, your End Point decided on, and your Total Drop figured out, you are ready to design the configuration of your ramp. A consideration here, also included in the checklist, is whether you can use an existing porch at your ramp door or whether a TOP LANDING will need to be a part of your ramp. The TOP LANDING is a flat level platform at door {see diagram on next page} with enough space past door on same side as door handle to allow the person in wheelchair to come up alongside the door and be able to open door while still seated in chair (usually 24 inches if possible). This platform whether it already exist or you will be building it, will need to be level and 1/2 inch below bottom of door, thus leaving a small ledge to prevent water ponding on platform being able to run under door, but not such a big bump that would prevent the wheelchair from easily going over it. If you are building a Top Landing it will generally be 5 feet by 5 feet (better detail of this in a drawing in section with building specs), which will accommodate the ramp leaving straight off from Top Landing or 90 degrees off of either side.

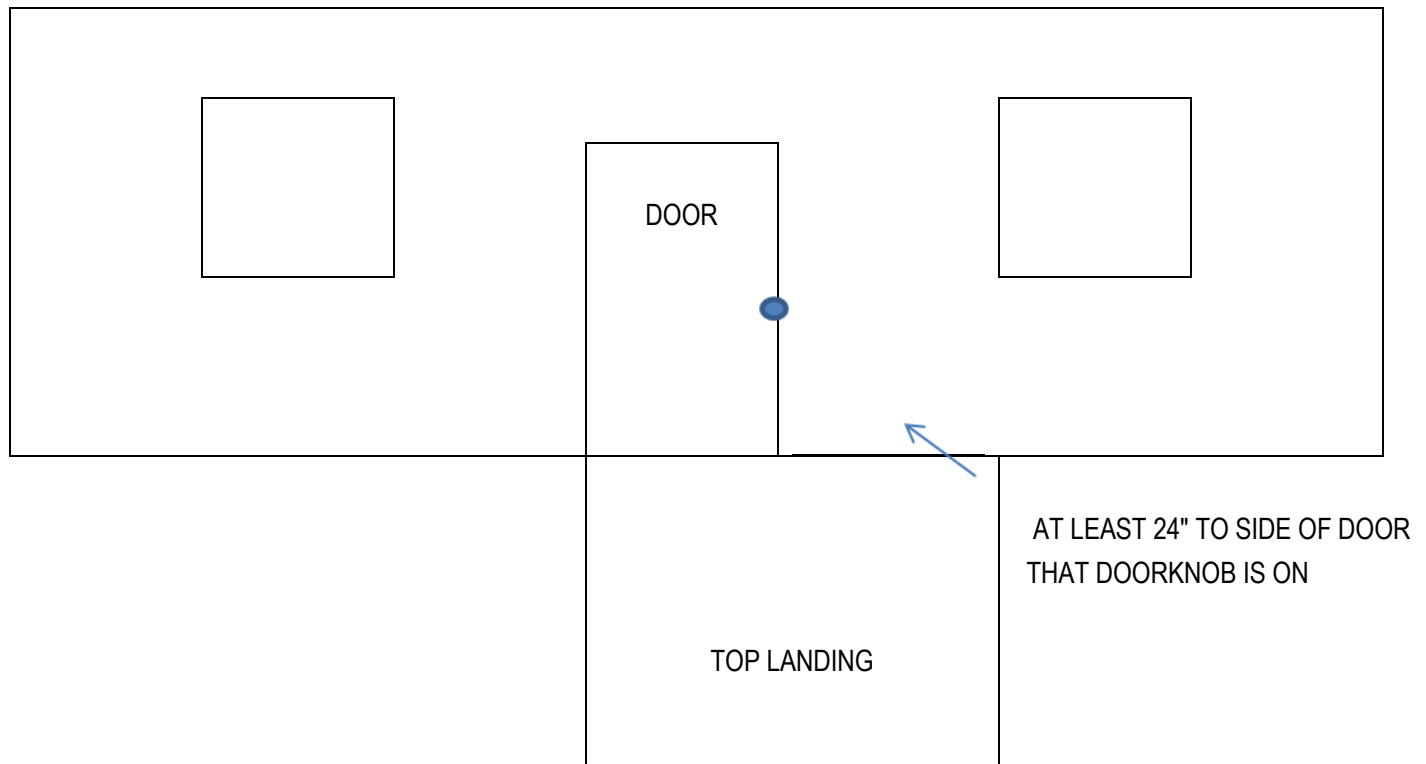

7. Determining How Many Feet of Ramp

With the starting point figured out and having decided whether you are coming off of an existing porch or a Top Landing that you are building, it is now time to start figuring out how you are going to get to your End Point using the required slope of 1 foot of ramp for every 1 inch of vertical drop or as referred to here as your Total Drop. Let's say for example you have a 24 inch Total Drop. Measuring from your Top Landing to your end point you only have 12 feet. You need 24 feet of ramp and with any ramp in excess of 20 feet (the ADA, American Disabilities Act Specs call for a Rest Landing every 30 feet) you will need a REST LANDING somewhere in your ramp design. A Rest Landing is a 5 feet or greater section of ramp that is installed level at some point to give the person in the wheelchair or the person pushing the wheelchair a safe place to stop and rest. It is the same width as your ramp unless again you are changing directions at this landing. So to continue with our example: You need 24 feet of ramp plus 5 feet of Rest Landing or 29 feet of run before you get to your End Point. In this scenario you have to go in another direction and make a turn to get the 29 feet in and end back up at your End Point. Don't forget to figure in having a 3 foot wedge module at the end of ramp to get you to ground level, unless you dig out enough so that the end of your last module ends level with ground.

8. Which Ramp Configuration

Your particular circumstances will determine which of the 3 following ramp designs will best fit your needs and in what configuration. In the following section “Making the Plans”, you will find all 3 designs in as many configurations as possible so that you can show the homeowner the design you have in mind and the configuration of how it will be built. Consider also in this initial planning, whether any existing steps can still be utilized for other guest to access door without having to use the ramp. This may involve moving steps or building new steps.

9. Do You Need a Building Permit

There are some other tasks you will want to take care of during your initial visit. If your county or city requires you to get a Building Permit, there are some things you can do now to help yourself or the homeowner in applying for the Permit. Whether you are getting permit on behalf of the homeowner or they are applying themselves, you can help take some of the anxiety and burden away from this process by doing some of the leg work during your first visit. 1) If you already have the application you can obtain the information it asked for now and have the homeowner sign it. 2) most counties or cities will require a site plan. A site plan is a birds-eye view of the home lot showing the boundary line, how far the house sits from each boundary, what streets border the property, where the water lines and septic lines or system is located, where the ramp will be placed and how far the ramp is from property lines. (An example of a site plan is given in Appendix B)

Hopefully the checklist at the end of this chapter will help you remember these things to do during your initial visit. (Checklist is also included in Appendix B- you can make a copy of everything in Appendix B and have everything you will need in the way of forms and such for your visit)

Illustrations of Typical Ramp Designs

180 DEGREE RAMP

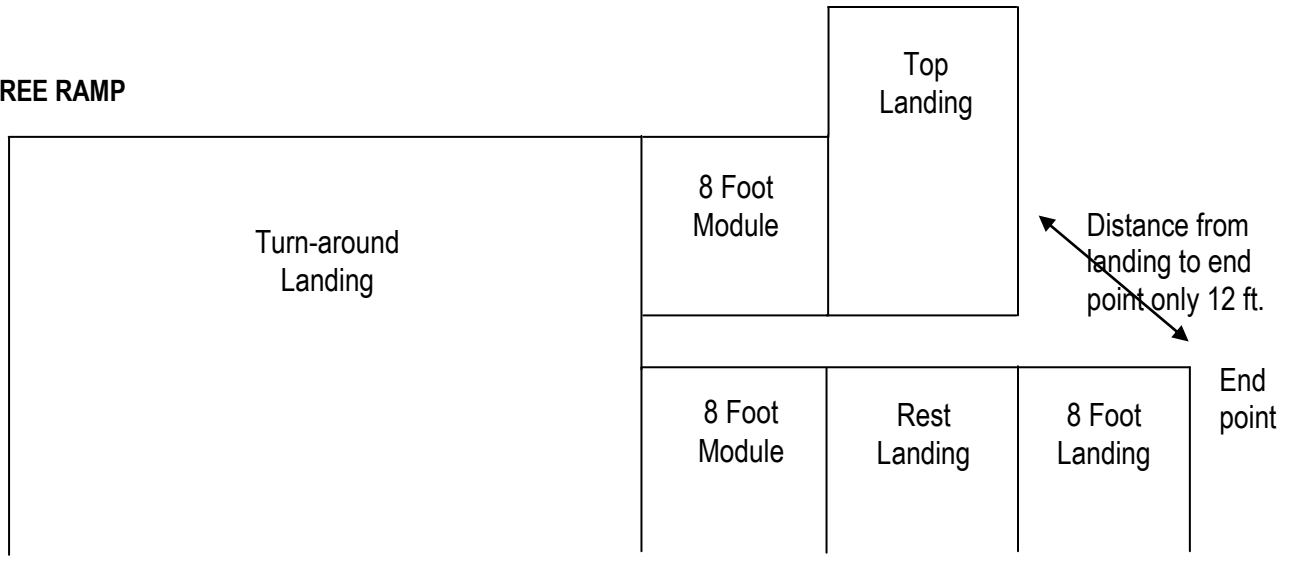

The first factor in determining to use this design is primarily when the distance between your Top Landing and your End Point is not enough distance to accommodate the length of ramp necessary due to your Total Drop. The flexibility of this design allows for different module lengths to be used to fit the length of ramp you need. Another thing to consider here is whether you can put steps off the other side of your top landing facing the end point. Assuming the end point is at a driveway and other visitors coming to the home might enjoy having access to some steps leading more directly to door than having to walk up the ramp.



The ramp pictured here may give you some idea of what the 180 design may look like. You can see here the rails have not yet been installed, but the ramp is almost completed at this point.

STRAIGHT MODEL

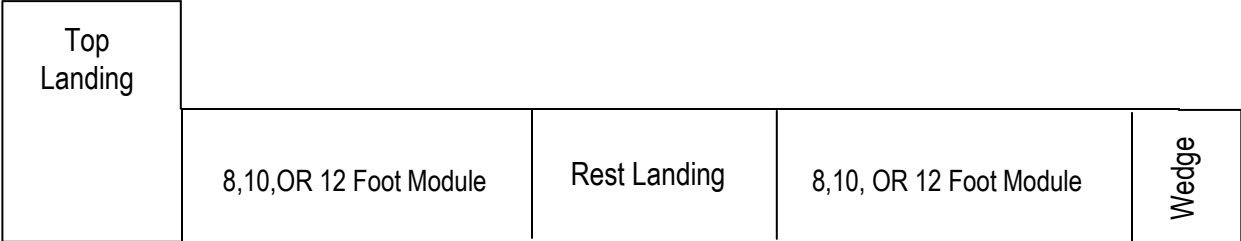

This design is used when there is adequate distance between your Top Landing and your End Point to handle the length of ramp to fit into your Total Drop. Ramp can come off either side or off front of landing. Flexibility here also is being able to use different module lengths.



This is a partial view of a Straight Ramp with a little kicker ramp to the side. So this dear lady could get down to her deck and still be able to enjoy a spring afternoon on her back deck.

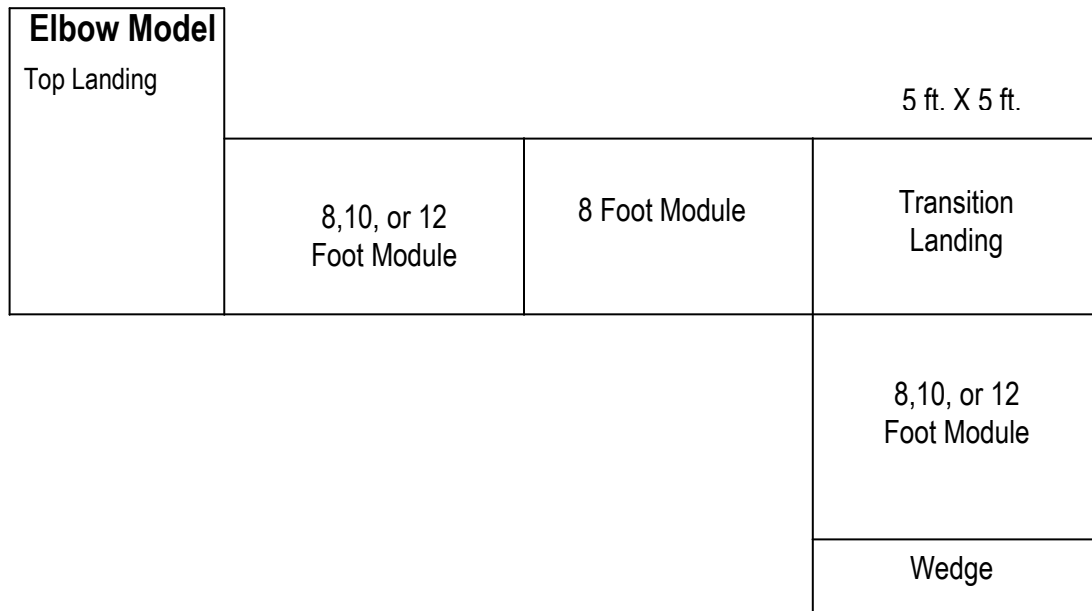

This design is used when there may be adequate distance between your Top Landing and your End Point to handle the length of ramp to fit into your Total Drop, but an obstacle may exist in your direct path or your endpoint is not straight off in any direction from your Top Landing.

Ramp can come off either side or off front of landing. Flexibility here as in other designs is to use different module lengths.

YES NO N/A

Interview with Family:

- 1) Is disability anticipated to be a long term situation? YES NO N/A
- 2) Are there family members who regularly help care for person? If no, this could have some bearing on your design of ramp, instead of a 1:12 slope you may consider a 1:16 slope YES NO N/A
- 3) Is family paying for material? YES NO N/A
- 4) If your group or church is paying for material, do you have an understanding with family that you would come and remove ramp if their situation changes in future and they no longer need the ramp? YES NO N/A
- 5) Is the family you are dealing with the owner of home? If not you need to talk to their landlord before preceeding past the planning stage. YES NO N/A
- 6) Actually #1, Have you prayed with family? YES NO N/A

Choosing door to place ramp:

- 1) Is this door easily reached on inside of house? YES NO N/A
- 2) Would this door be logical door for emergency personnel to get a person out of house if on a stretcher? If so, you don't want the ramp to be a hindrance to them. YES NO N/A
- 3) Are there any unmovable obstacles outside that might be in the path of the ramp, such as a pump house or a carport, etc.? YES NO N/A
- 4) Looking at where last ramp module will meet ground at your End Point, is there concrete or anything else that would hinder you from digging out so end of ramp is at ground level? YES NO N/A
- 5) Is there an existing porch at door where ramp will be located, if yes, will it be sufficient to support the top of your ramp, and does it allow enough room past the side that door handle is located for person in chair to be able to get close enough to open door and door to swing past chair unobstructed? YES NO N/A
- 6) If answer to q. 5 is no, can steps be removed, and a Top Landing be built to give the space needed past door as mentioned in 5 above. Note: In most cases you will be able to use the steps in your design. YES NO N/A

RAMP DESIGN:

- 1) Have you located your END POINT?
- 2) Determine your TOTAL DROP per the steps outlined in this manual.....
- 3) Measure the distance between your door and your END POINT.....
- 4) If your Total Drop is any more than the measurement in step 3, you may have to look toward a 180 ramp..
- 5) Consequently if the measurement in step 3 is more than your Total Drop you may can go with a straight ramp or a elbow ramp design.

COUNTY OR CITY REQUIREMENTS:

- 1) Most if not all county and city ordinances prohibit placement of ramp over water lines or any part of septic system. Have you located water lines and septic system and determined that ramp placement will not be covering any part of either system.
 - 2) Have you made a scaled drawing of property lines and house placement on lot, outlining the setback from each property boundary, and the location of water lines and septic system, and the placement of the ramp.
 - 3) Unless you already have an established relationship with county or city building inspector's office, have you prepared drawings of how the landings and modules are constructed and then assembled on the site.
 - 4) If you are getting permit on behalf of homeowner you may want to still get their signature on application?
- Once you have that relationship established with their office or 1 peticular inspector in their office and they know how you construct your ramps, they usually will not then require you to submit detailed drawing of your ramp construction, but you will still need a birdseye view drawing of the house, water lines, septic system, and location of ramp.

Chapter 3

Making the Plans

1. REFINING YOUR PLANS

Now you can take the rough drawing(s) you made at the site and refine them such as where to place your support post and pre-planning your rails. These drawings are all an important part of your overall plan and will help later when ordering your materials. On the following page sketches give an example of planning the placement of the post and how this also plays into the rails. Drawing out your design can help you in determining how many post you will need. At the Top Landing it may be that due to the height of your door from the ground it may take a whole post for each post you need, whereas after you start down the ramp the height of your post needed gets shorter and shorter and possibly to a point that the amount of post you cut off can be used for one of the even shorter post further down the ramp. It is helpful not only to have a birds-eye view of your ramp that helps you figure out your post placement, but a side view which gives you a general idea of the height of your ramp at various points.

General Rule: Top Landing gets 6 posts
 Modules get 2 posts
 Rest Landing gets 4 posts
 Turn-around Landing gets 5 posts

2. ORDERING YOUR MATERIALS

Included in this manual are some manual worksheets for figuring up your materials. If you feel you are not computer savvy enough or just don't have access to a computer you can plug in the applicable numbers in the applicable boxes and with a calculator you can do the math and come up with your materials list.

If you are computer savvy, included with this manual is an Excel Worksheet that will figure your materials as fast as you can drop in the numbers. You simply drop in how many 8 foot, 10 foot, or 12 foot modules you need for your ramp in the applicable yellow boxes. You drop down and enter how many Top Landings and Rest Landings you need in the applicable boxes. Down toward the bottom of the worksheet you enter your local cost for the different materials listed, again in the applicable yellow boxes. As quick as you can enter these numbers this worksheet will have figured the quantity of each item you will need and also an estimate of your cost.

You could have this worksheet on your laptop and carry it on your initial consultation visit and after making your rough plan and arriving at a pretty good estimate of the modules and landings you will need, you could drop these numbers in this program and give the homeowner a good cost estimate right there on the spot.

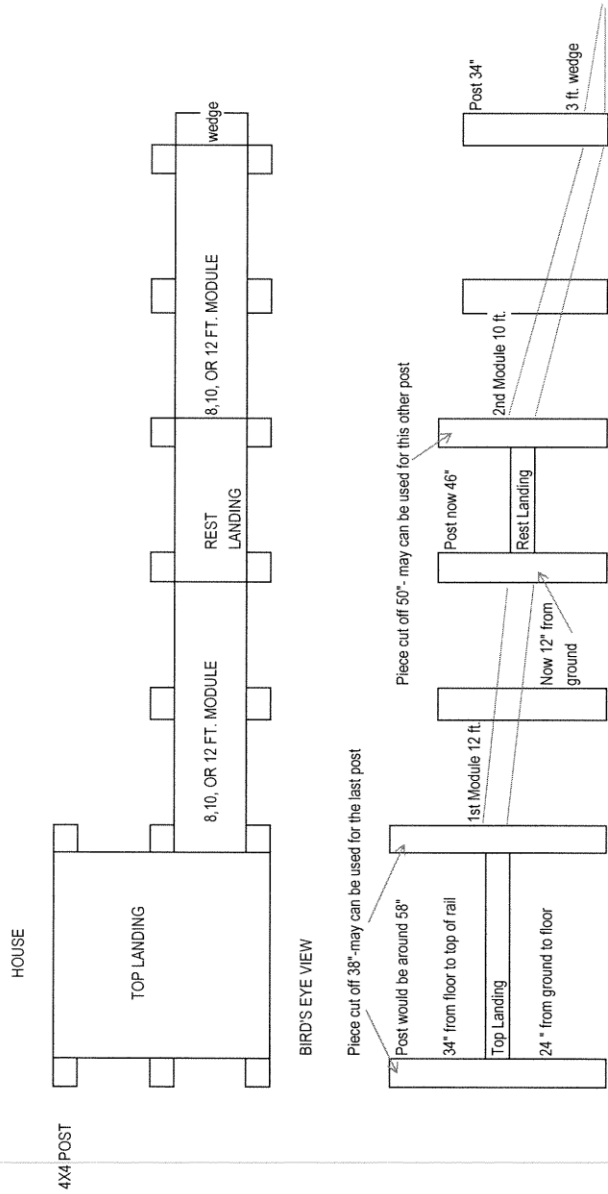

In this example, we can probably use 2 of the pieces cut off of 2 of the post at the Top Landing to make the end post at the low end of ramp. So we will need (6) post for the Top Landing. The post halfway down your first module will be around 52" so the cut off piece will be around 44" and possibly can be use for the post halfway of your 2nd module. So you need (2) post here . The first 2 post at the rest landing will be whole post (2) but the cutoff pieces should make the other 2 post at your rest landing. In this example you might only need 10 post.

8', 10', or 12' MODULE

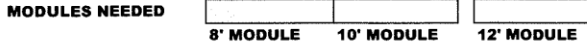
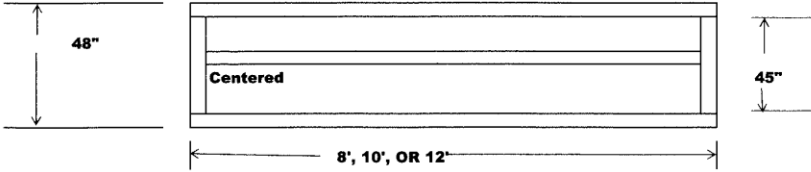

FRAMING				Totals
2X6- 8'	4	1	1	
2x6- 10"		3		
2x6- 12'			3	
5/4 X 6 DECKING- 12'	6	7	8	
4X4 POST -8'	2	2	2	
GIRDER 2X6-8'	1	1	1	
HARDWARE				
6 " BOLTS 5/8	2	2	2	
4" BOLTS 5/8	4	4	4	
FLAT L BRACES	4	4	4	
2X6 JOIST HANGERS	2	2	2	
WASHERS	6	6	6	
NUTS	6	6	6	
BLOCKS (solid)	2	2	2	

RAILS	10'	12'	14'	
2X4x10	6			
2x4x12		6		
2x4x14			6	
5/4 x 6 Decking (cap) 10	2			
5/4 x 6 Decking (cap) 12'		2		
5/4 x 6 Decking (cap) 14'			2	

Use a joist hanger on both ends of center joist.
 Precut your decking boards 48". If you have enough help to handle the modules, you can pre-install the decking.
 After you build module, and before installing decking, square module and hold in place with a brace diagonally on one end at least until you get a few decking boards attached at the other end.

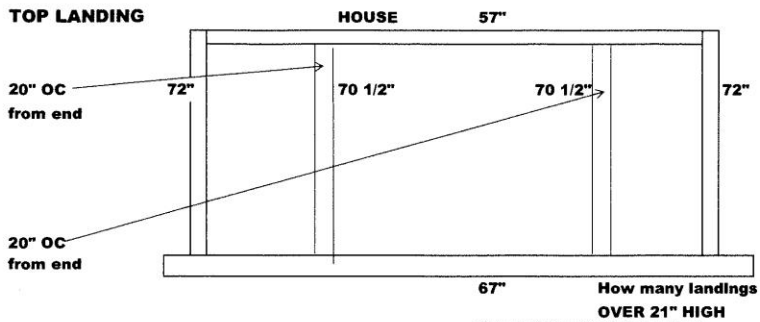

FRAMING	NUMBER NEEDED	How many landings OVER 21" HIGH	
			Totals
2X6- 12'	3		
2x6- 12"(Girder)	1		
5/4 X 6 DECKING- 10'	6		
4X4 POST -8'	5		
HARDWARE			
8 " BOLTS 5/8	12		
4" BOLTS 5/8	0		
FLAT L BRACES	4		
2X6 JOIST HANGERS	4		
WASHERS	12		
NUTS	12		
BLOCKS (solid)	8		
RAILS			
2X4 10'	0		
5/4 x 6 Decking (cap)	0	10'	

If this landing is not supported by sl top of an existing porch you should lateral bracing if over 21" high from

The Top Landing is the only module that has to be adapted to each job. The drawing above comes off the house 6 feet. Thi out far enough to get ramp out from under the overhang on the house. You do not , if possible, want rain or snow running o onto your ramp. It may be where you need to come out far enough to get past shrubbery. In cases where you are putting this landing over or on an existng landing or porch, you have to make changes to accomm the rise between the existing porch and 1/2 inch below door sill. You may have to rip your 2x6 joist down or move up to a ; The post placement at the end of landing facing the road depends on whether your first module is coming off either side or if coming off the front move your post out to the front instead of the inside as depicted on the drawing above.

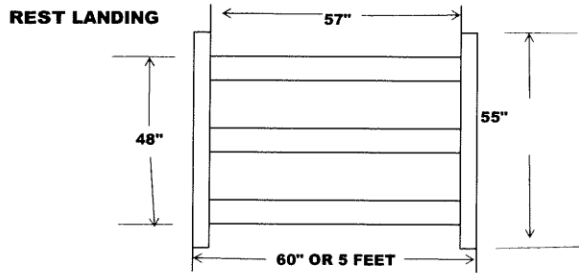

FRAMING		NUMBER NEEDED	Totals
2x6- 10'	3		
5/4 X 6 DECKING- 12'	4		
4X4 POST -8'	4		
GIRDERS 2X6-10'	1		
HARDWARE			
6 " BOLTS 5/8	4		
4" BOLTS 5/8	0		
WASHERS	4		
FLAT L BRACES	4		
2X6 JOIST HANGERS	2		
NUTS	4		
BLOCKS (solid)	4		
RAILS			
2X4 10'	3		
5/4 x 6 Decking (cap)	0	10'	

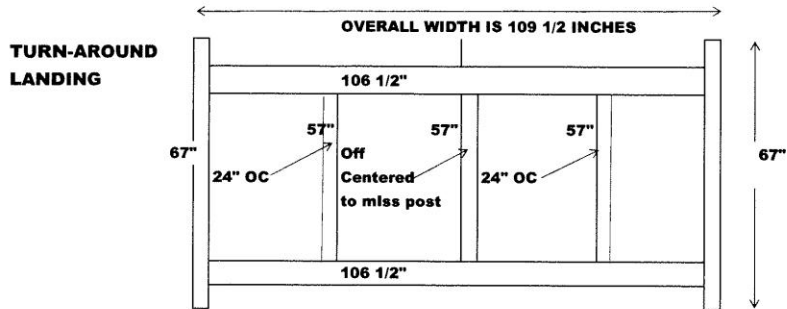

FRAMING	NUMBER NEEDED	Totals
2X6- 8'	0	
2x6- 10'	4	
2X6- 12'	1	
5/4 X 6 DECKING- 10'	11	
4X4 POST -8'	6	
HARDWARE		
6 " BOLTS 5/8	6	
4" BOLTS 5/8	0	
WASHERS	6	
FLAT L BRACES	4	
2X6 JOIST HANGERS	6	
NUTS	6	
BLOCKS (solid)	6	

RAILS		
2X4 10'	3	
5/4 x 6 Decking (cap)	0	12'
2x4 12'	3	

QUICK ESTIMATE

YOUR LOCAL COST	2x4x10	2x4x12	2x4x14	2x6x8
TOTALS TO ORDER				
COST ESTIMATE				

2x6x10	2x6x12	5/4 Decking 10'	5/4 Decking 12'

5/4 Decking 14'	4x4x8 Post		

Flat L Brackets	6" BOLTS 5/8	4" BOLTS 5/8	WASHERS	bolts,nuts, & washers

Nuts	2x6 Hangers	Post Blocks	Post Block are shaped like a pyramid

TOTAL RAMP ESTIMATE: \$ -

This material list is based on a handrail setup like depicted under the tab below that says rails . Alter this list if you do y

YOUR CHURCH NAME

RAMP MATERIAL ORDER LIST

JOB NAME:

2x4x10

2x4x12

2x4x14

2x6x8

2x6x10

2x6x12

5/4 Decking 10'

5/4 Decking 12'

5/4 Decking 14'

4x4x8 Post

Flat L Brackets

6" BOLTS 5/8

4" BOLTS 5/8

WASHERS

Nuts

2x6 Hangers

Post Blocks

PLEASE DELIVER MATERIALS TO:

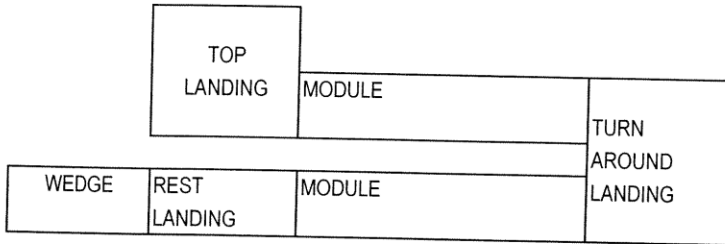

TOP LANDING SIZE _____

MODULES: 8 FOOT _____
 10 FOOT _____
 12 FOOT _____

REST LANDING _____

WEDGE SIZE _____

NOTES:

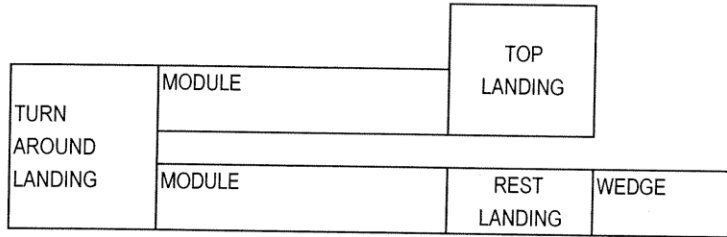

TOP LANDING SIZE _____

MODULES: 8 FOOT _____
 10 FOOT _____
 12 FOOT _____

REST LANDING _____

WEDGE SIZE _____

NOTES:

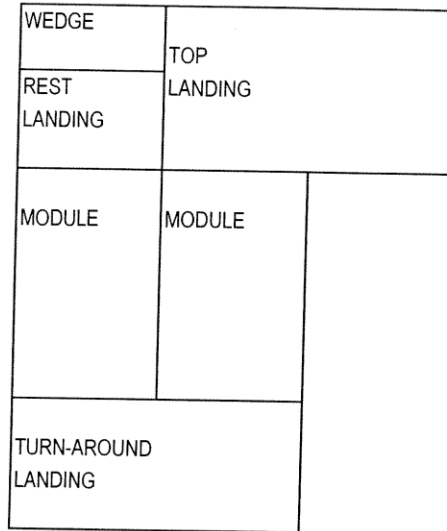

TOP LANDING SIZE _____

MODULES: 8 FOOT _____
 10 FOOT _____
 12 FOOT _____

REST LANDING _____

WEDGE SIZE _____

NOTES:

Handwritten notes and scribbles at the bottom of the page, including the number '10' and various illegible markings.

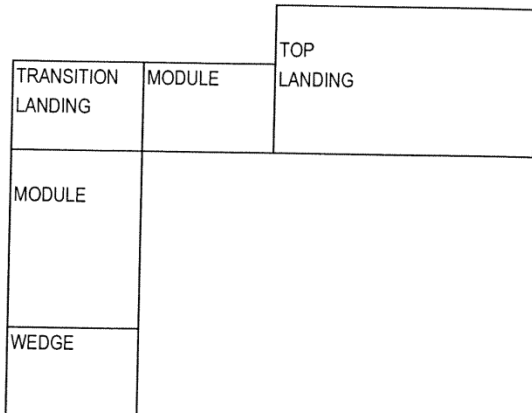

TOP LANDING SIZE _____

MODULES: 8 FOOT _____
 10 FOOT _____
 12 FOOT _____

REST LANDING _____

WEDGE SIZE _____



NOTES: _____



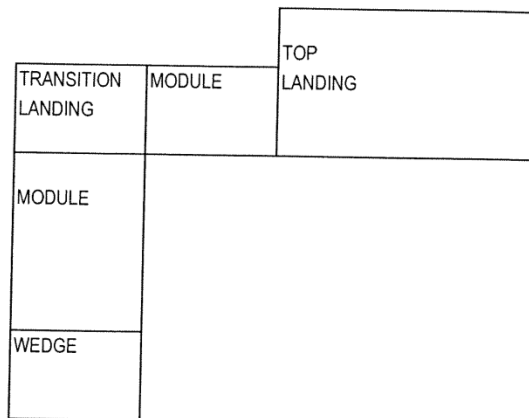

TOP LANDING SIZE _____

MODULES: 8 FOOT _____
 10 FOOT _____
 12 FOOT _____

REST LANDING _____

WEDGE SIZE _____

NOTES:

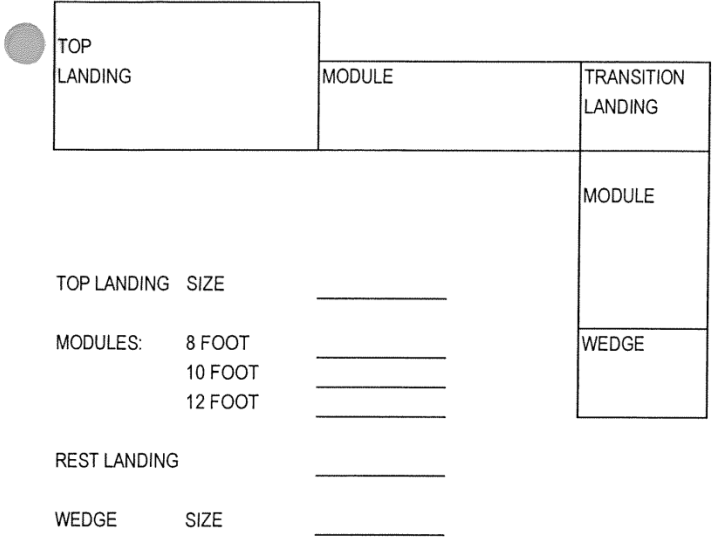

NOTES:

TOP LANDING SIZE _____

MODULES: 8 FOOT _____
10 FOOT _____
12 FOOT _____

REST LANDING _____

WEDGE SIZE _____

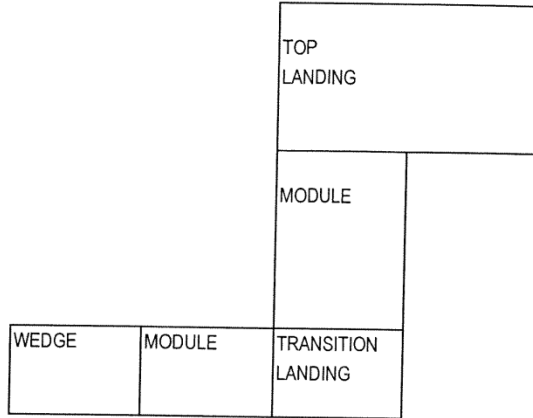

NOTES:

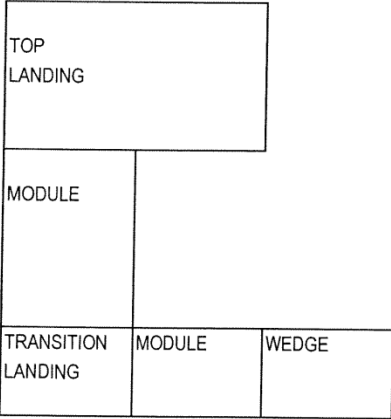

TOP LANDING SIZE _____

MODULES: 8 FOOT _____
 10 FOOT _____
 12 FOOT _____

REST LANDING _____

WEDGE SIZE _____



NOTES: _____



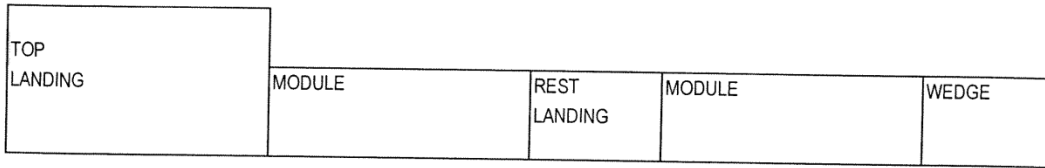

TOP LANDING SIZE _____

MODULES: 8 FOOT _____
 10 FOOT _____
 12 FOOT _____

REST LANDING _____

WEDGE SIZE _____

NOTES:

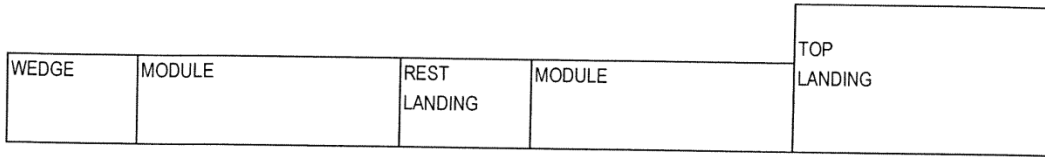

TOP LANDING SIZE _____

MODULES: 8 FOOT _____
 10 FOOT _____
 12 FOOT _____

REST LANDING _____

WEDGE SIZE _____

NOTES:

TOP
LANDING

MODULE

REST
LANDING

MODULE

WEDGE

TOP LANDING SIZE _____

MODULES: 8 FOOT _____
10 FOOT _____
12 FOOT _____

REST LANDING _____

WEDGE SIZE _____

NOTES: _____

Chapter 4

The Pre-Build

1. THE PRE-BUILD

Now with your plan in place, a design on paper, and your materials on hand you are ready for the pre-build step. I call this the pre-build because you can build a lot of your ramp ahead of time in someone's shop. The landings and modules can be built, the decking boards can be cut and pre-drilled and in some cases your post can be pre-cut. We will discuss each of these in more detail.

The advantage of pre-building is being able to utilize those guys who may not be able to work on the project during the day, even on a Saturday, but might can give you 2 or 3 hours one night. Working in someone's shop means you do not have to schedule around the weather. Most guys would rather be doing this on a rainy night than at home watching a rerun on the Lifetime channel. All the time spent ahead of time is less time at the job site. It is easier to get your guys to commit to a Saturday morning or afternoon than a whole day. It also better utilizes your men. Instead of building your modules at the ramp site where a couple of your guys are measuring and cutting and the others are standing around waiting for something to do. In a typical shop setting you can have several stations setup so that all your men on hand are busy with a particular job.

You can have 2 guys measuring, cutting, and laying out the joist for the landings and modules and 2 guys doing the actual assembly. At another station you could have 2 men cutting and pre-drilling your deck boards. You could even use another 2 men to start installing the decking boards on the assembled landing or modules as they come from the assembly station. If in the perfect world you had a setup like this with 8 motivated men at these 4 stations, you could finish the pre-build of a typical ramp before your wife even realized you were not in the house.

A typical pre-build with 4 or 5 guys will be 3 to 4 hours. The typical on-site construction can be 3 or 4 hours to get the ramp useable, and then maybe a final finish trip of 2 or 3 guys for 2 or 3 hours to finish the handrails. I have found it easier to get most guys to commit to a Saturday morning with a promise we will quit by lunchtime. This may not be the case with your group. You may find it easier to do it from start to finish without a 2nd trip to do the rails for example.

2. Let's get building

Building your Top Landing: (If your plan calls for one) as shown on the material worksheet the typical size is 5 foot by 5 foot. Your plan may call for a different size, and if so you can modify the materials list accordingly. The plans are sized in part to utilize the normal lumber lengths available at most lumber places and to minimize

waste. Build the landing and square it using your normal methods of measuring diagonally or using a framing square. Install your L corner braces on what it to be the bottom of your module and install your hangers at each end of your center joist. Your decking boards should be cut to 60" and predrilled. Drill 2 holes on each end so they will intercept the center of the joist of the landing and then drill 2 holes to match the 2 center support joist that are at 20" from outside edges. If you will have enough help on hand to handle the extra weight, you can go ahead and attach the decking boards to landing. While installing the decking boards make sure you keep the joist flush with the decking boards as you progress from one end to the other. Later during construction at the site you will appreciate them being flush when you get ready to install your post on the side of your landing.

3. Building your Modules

Following your plans and the specs outlined here you build whatever modules you need for your plan. As with your Top Landing your decking boards can be precut and predrilled. Of course your decking boards here will be 48" with 2 holes drilled on both ends with 2 holes drilled in center. When installing your boards again keep the joist flush with both ends of your decking boards. Again installing your flat corner brackets on bottom of module at each corner and your hanger at each end to support your center joist. All your modules are built the same with the exception of your Terminal Module. The Terminal Module is the last module whose lower end will meet the ground, or referred to as the terminal wedge. With the low end of your last 8, 10, or 12 foot module setting on or at ground level you are still 5 to 6 inches off of ground. A short module of 3 to 5 feet tapered down to a point and the same width as your ramp will get you down to the ground or driveway where your ramp will end. See the picture on page 4-9 of a wedge module to get an idea of how to build this module and how to attach it to the module just above it. Not shown on the following picture you can attach the very last decking board to this module with 2 hinges. This extends the length of this module another 6 inches with the hinges attaching this board at a point where your truss is too thin for your decking screws anyway. You can also pre-drill the (2) 5/8" holes in each end of your modules that will be meeting either your Top Landing or a Rest Landing. See illustration below:

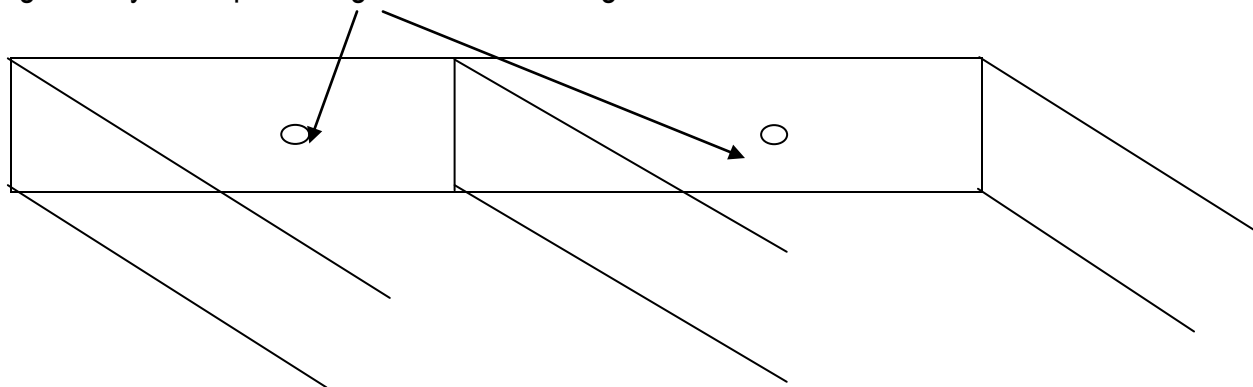

4. Building the Rest Landing

Building this landing is just a small ramp module. It is 48" wide but only 5 feet long. Your decking boards for this Landing are the same as your modules and they can be pre-cut and pre-drilled just as you did with the modules. The exception to this is when you are changing directions (referred to as a transition landing) such as in the Elbow Design shown previously. In this situation the landing should be a minimum of 5 feet x 5 feet. (see picture of a rest landing on page 4-13)

5. Building the Turn-around Landing

This landing is built very much like a top landing except it is wider (106 ½" to be exact) to accept the module coming down from top landing and beside it the module that leaves going down toward your end point. The joist here can be placed 24" on center from each of the ends of landing and then 1 joist at dead center. (see picture of a turn-around Landing in picture on page 4-8).

6. Girders

Something that your county or city inspector may or may not require is support girders at the load bearing points of your ramp. Even if not required, putting girders from post to post under your ramp will take most of the load bearing off the bolts and shift it to the girders. The recommended placement of the girders can be seen in the drawings on the next page. The materials worksheets reflect the ordering of material for these girders. If you are not required by your inspector and you really feel this is overkill then you can adjust your materials order accordingly.

Ramp Modules

8'-10'-12'

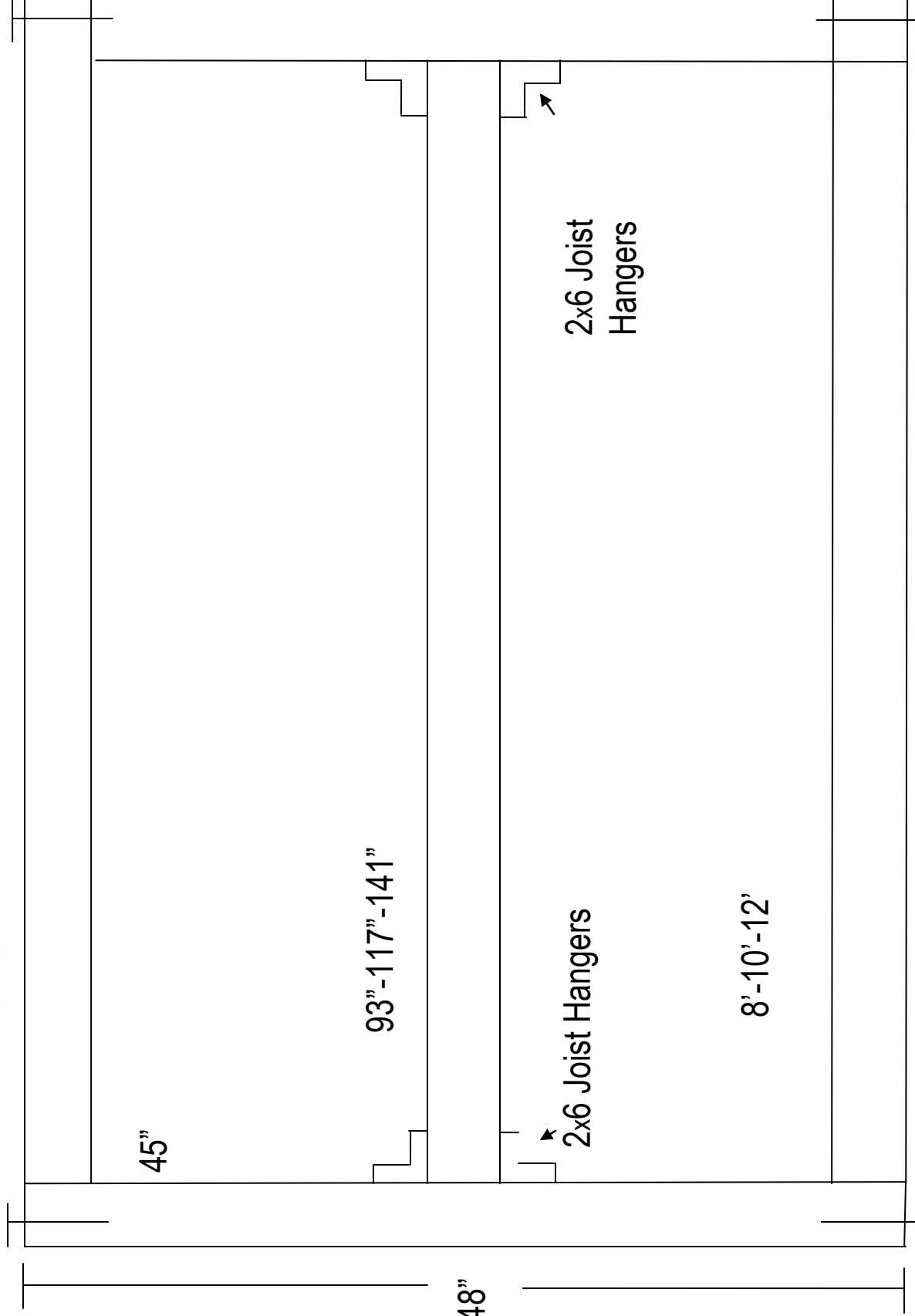

- Decking Boards – 48"-predrilled
- 8' module-17 decking boards needed
- 10' module-21 decking boards needed
- 12' module-25 decking boards needed

Rest Module

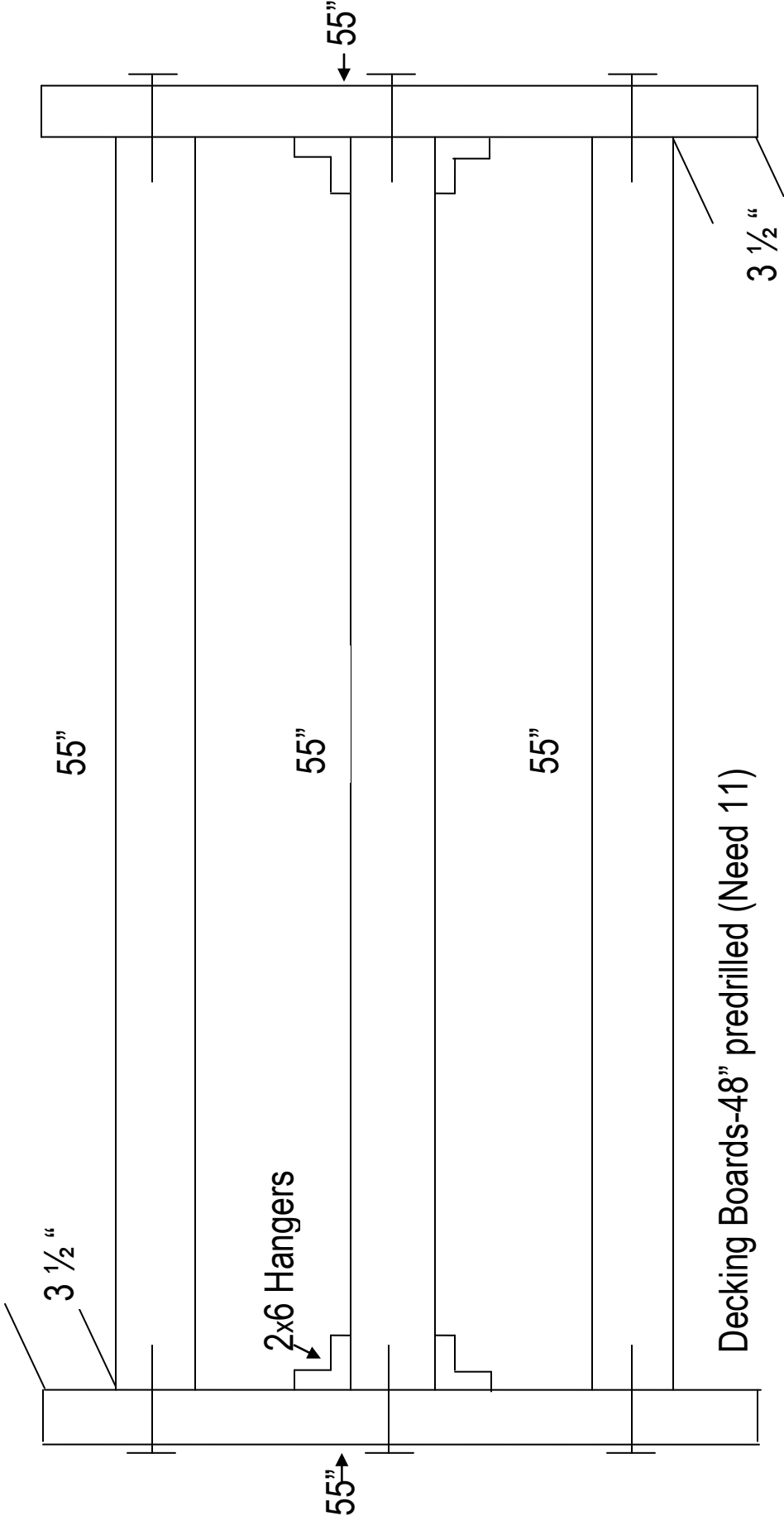

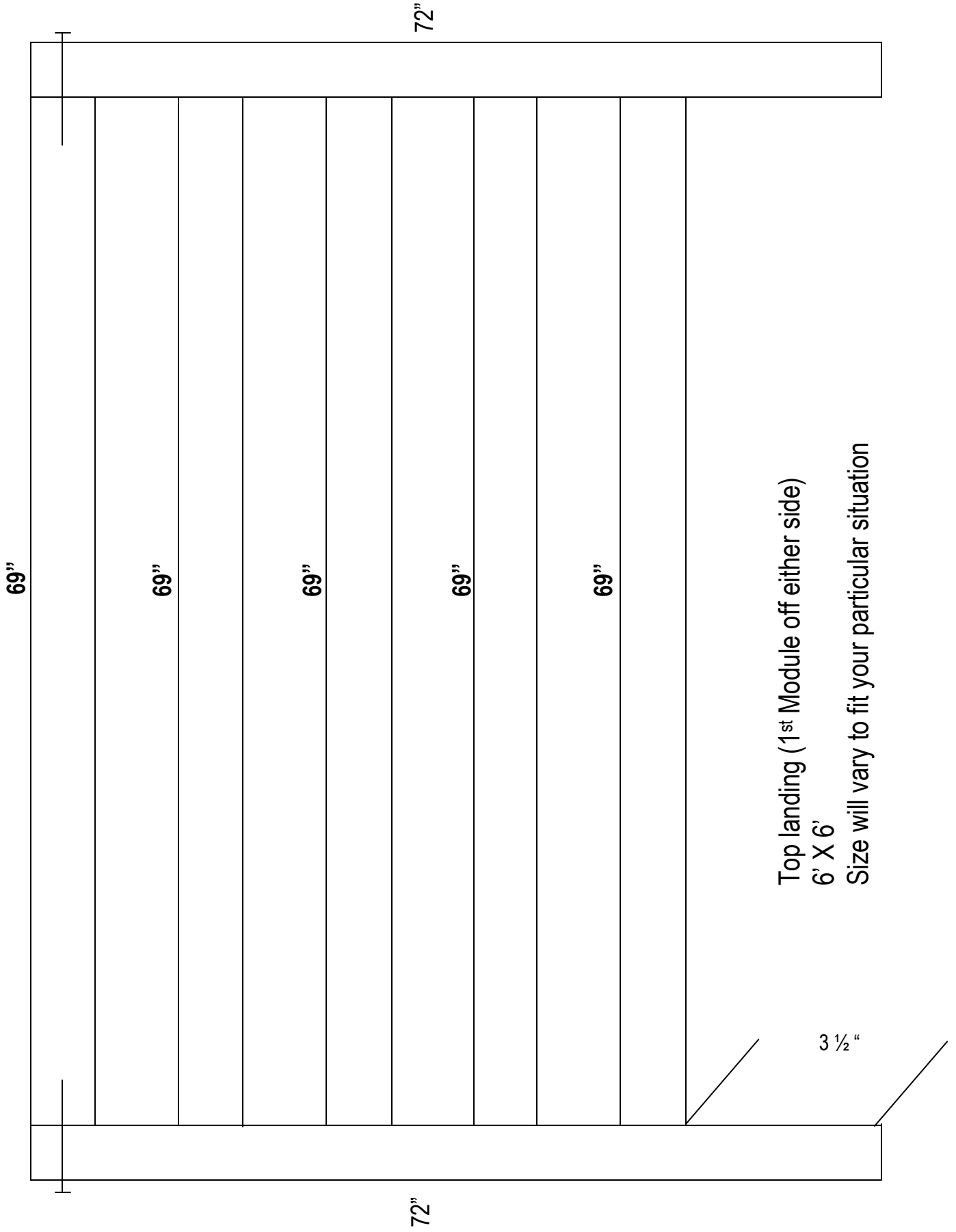

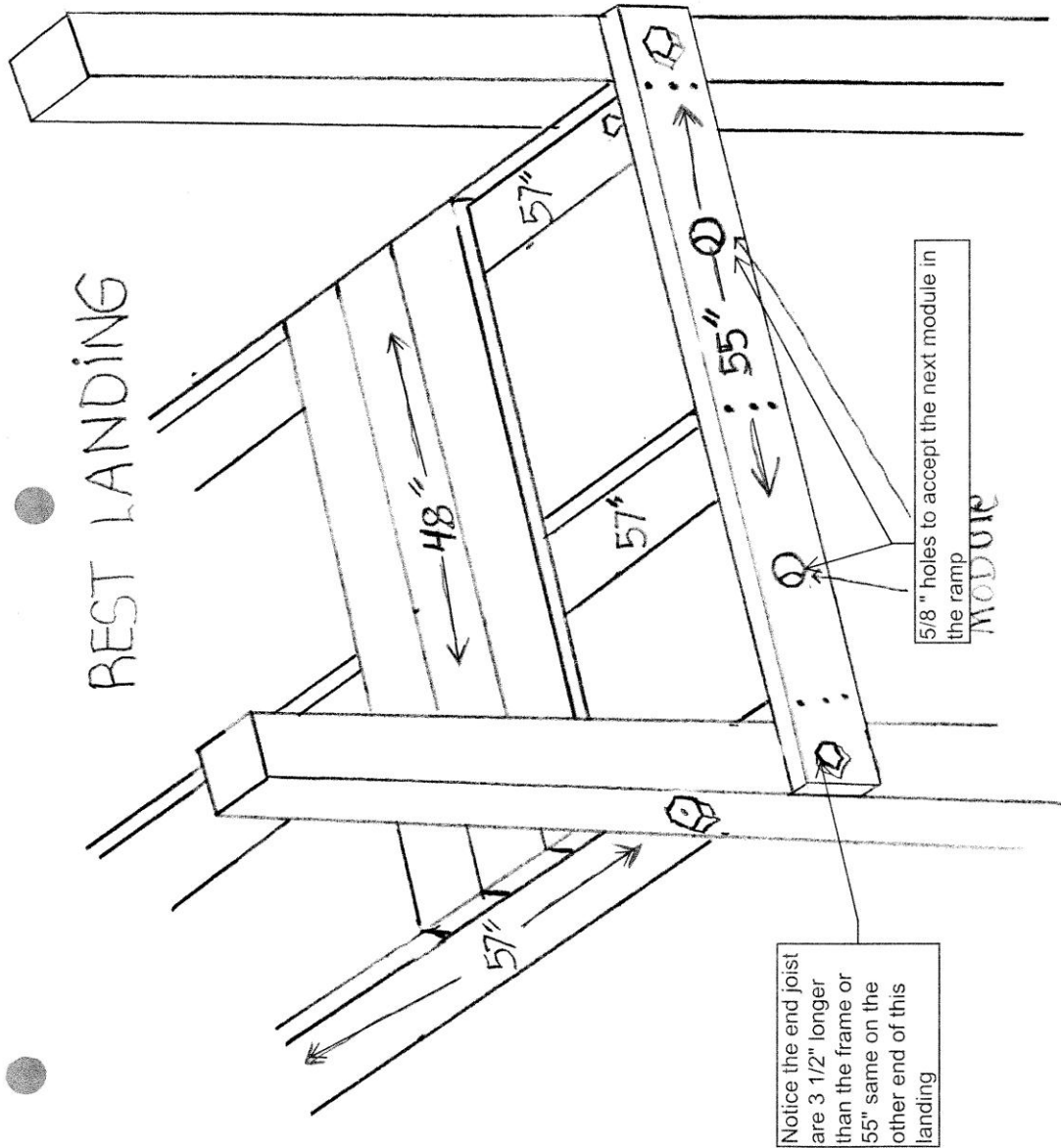

TURN AROUND LANDING

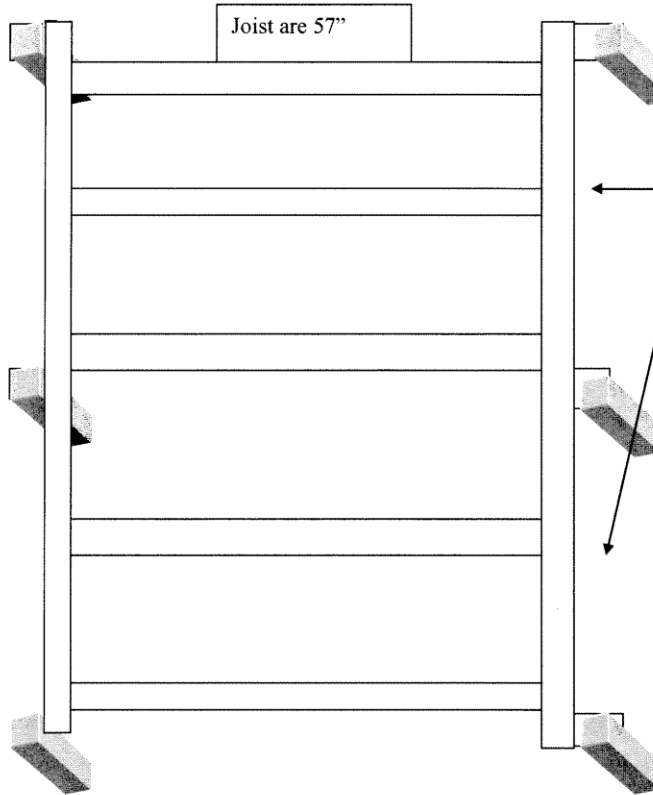

The Turnaround Landing used with the 180 Degree Ramp Style. Pictured here is the basic design of the frame part of the landing.

Overall length of landing is 106 1/2 inches by 60 inches. The 106 1/2 length accommodate the 48 inch wide module coming down to it from your top landing and the 48 inch module leaving it down to the ground.

This can be modified to a wider landing if you would prefer to have the 2 modules further apart. In this design the modules share common post.

The 3 1/2 inch extension on each corner of landing is to give you a clean place to bolt your post to the frame without having to guess at your hole placement for bolts in order to miss the nails used to build frame.

Terminal Wedge Module
 To save you from doing a lot of digging to get the end of your last module down to ground level, you can use a small 3 foot wedge similiar to illustration. This is essential when your ending point is on asphalt or cement or even a rock driveway.
 If you place your last post here you can either lag this to the post or drill hole through this and your post and bolt it.

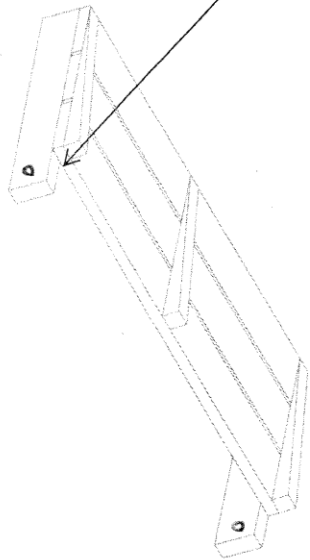

End Ramp Assembly
bottom view

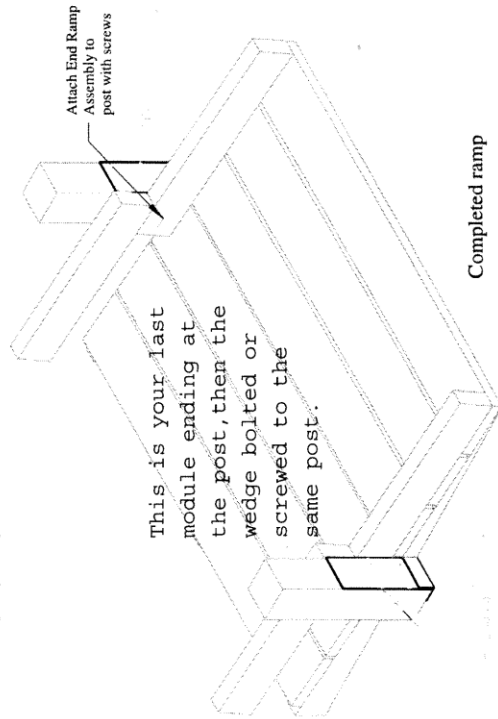

This is your last module ending at the post, then the wedge bolted or screwed to the same post.

Completed ramp

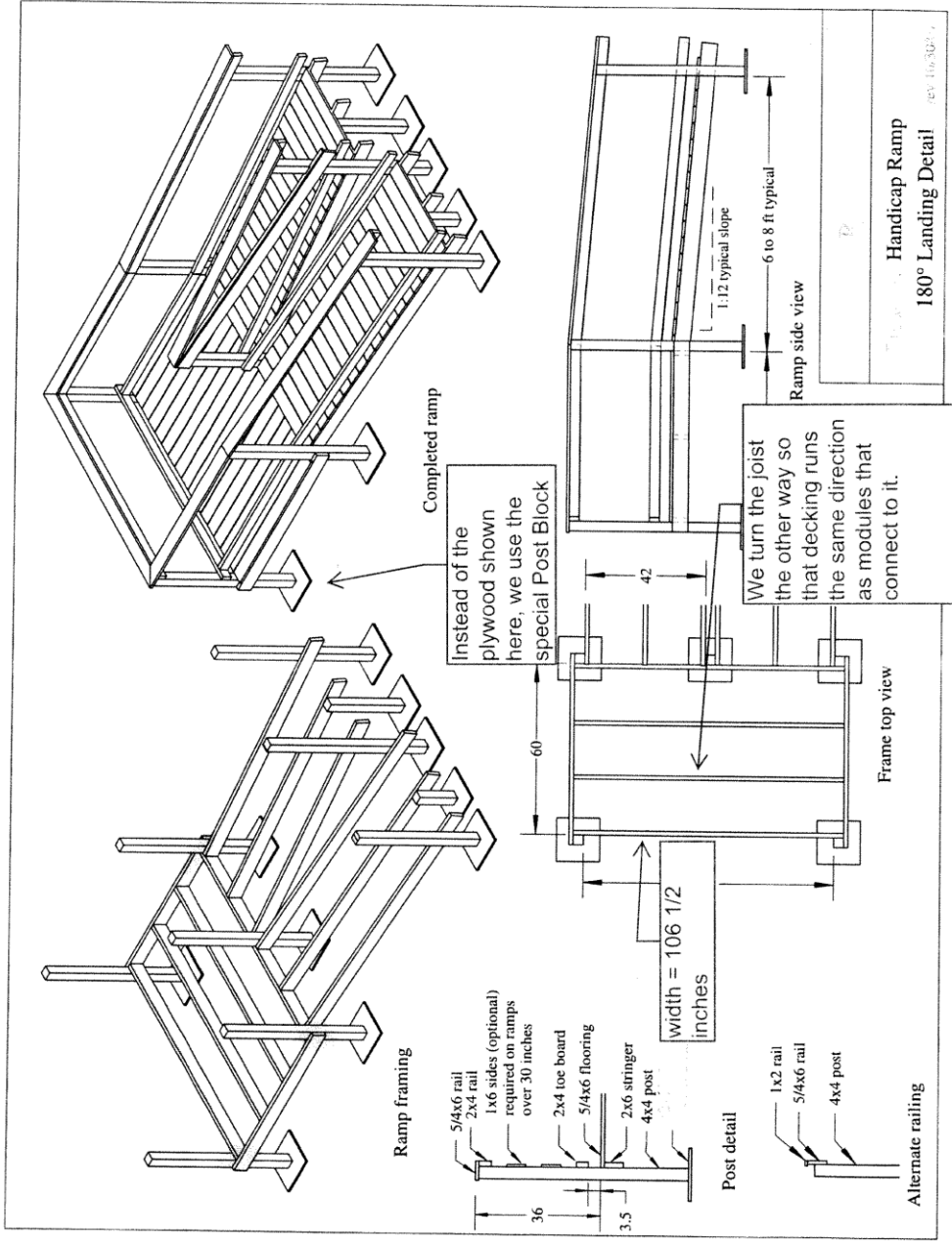

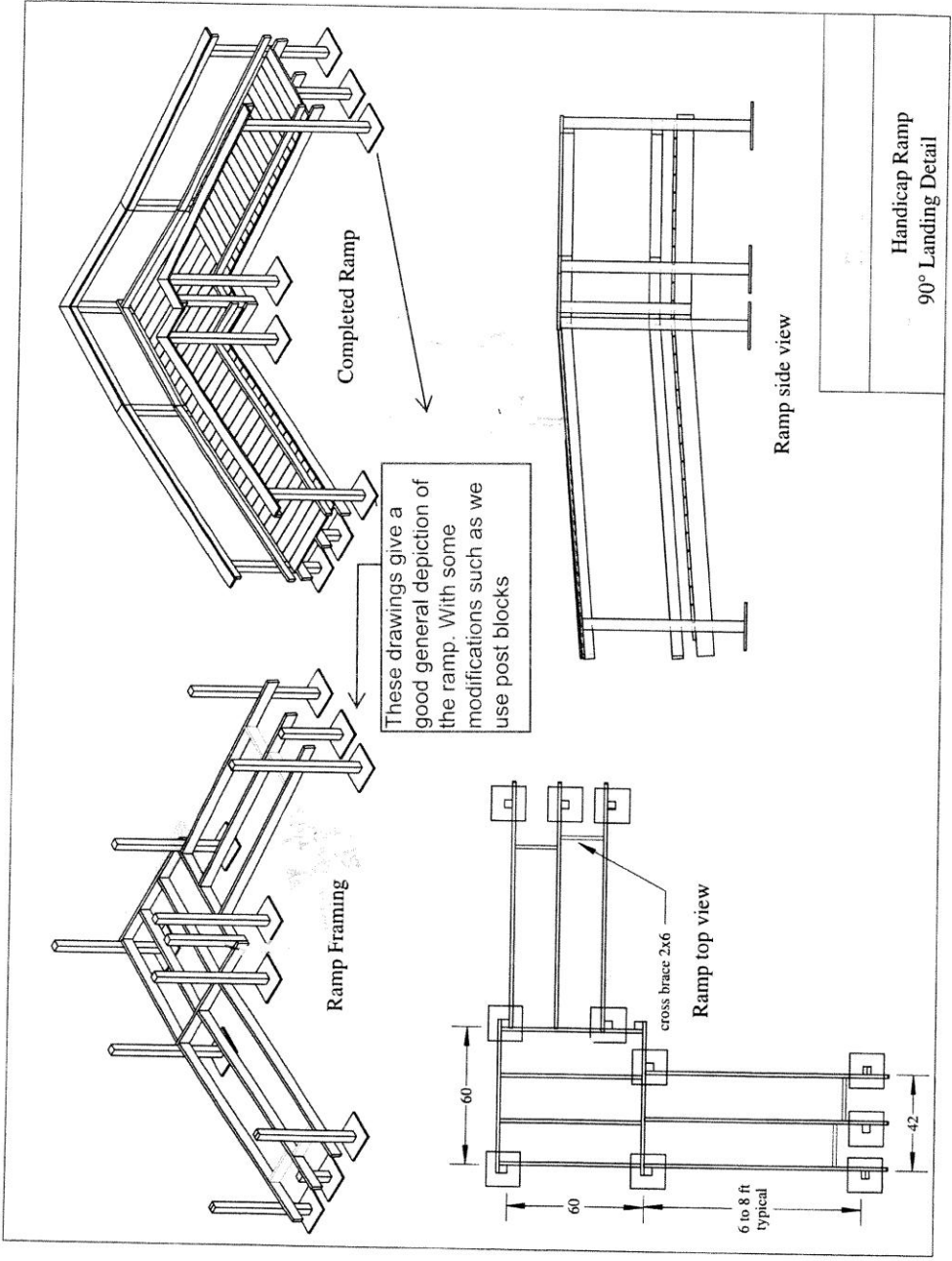

Chapter 5

At the Ramp Site

1. AT THE RAMP SITE

You have done your initial consultation with family, you have made and drawn up your ramp plan, and you ordered your materials and now have done all the pre-build steps you could do. It is now the day you have waited for, the build. Line up 5 or 6 guys and you are ready to go.

Review the Tools Needed list to make sure you will have all on hand at the site.

- Prayer
- Wooden stake (maybe 5 ft . 1x1)
- Carpenters line
- Line level
- Tape Measure
- 4 – 4” C Clamps
- 2 – 6” C Clamps
- 4 ft level
- Skill saw
- Hammers
- Drill (corded)
- 2 or more cordless drills
- Decking screws (2 inch)
- Long shanked bits to fit your decking screws
- Pointed shovel
- Small flat shovel or garden hoe
- Old pole type car jack (optional)
- Framing square
- T-Square
- Post hole digger
- Camera
- Chop saw
- Wrenches (box end to tighten nuts) or deck sockets
- Building permit (if required)

After arriving at site, make contact with homeowner and with your crew gathered, now is a good time to have a circle of prayer with the family. Pray for the safety of all involved and pray for the neighbors that might observe your work and that God will use what they observe of the work going on and the spirit of the crew doing the work to touch them in a special way. Be open and available to talk to neighbors who might stop by and wondering what is going on. This is a great opportunity to share that

what your guys do they do out of love for a Savior who first loved them and one way they try to show that to others is by helping their fellow man. You may want to consider having brochures about your group or business cards you can give if a neighbor expresses a desire to give a donation to your group.

2. Now let's get to work

The first order of business will be to remove the existing porch if you are replacing it with a Top Landing that you have built, or removing the steps to an existing porch if you are leaving it and the steps are positioned in the wrong place.

3. Top Landing

If you are providing the Top Landing, getting it in place, leveling it and getting your post attached will be one of the biggest steps in your assembly process. It always seems that once you get this landing in place, the rest of the ramp goes rather quickly. Hopefully right out of the gate you have enough manpower on hand so that 4 men can hold the landing in place so that maybe 2 other men can get a temporary leg on each corner. We normally just use a 2x4 and nail it (leaving enough of the nail head out to later pull it out) far enough from the end to leave room to install your corner post. Here you want to get the landing about ½ inch below the door threshold and level in all directions. With your landing positioned and level the 2 men can start getting the post attached. The 4 men who were holding the landing will still need to help steady it. It might still be a little shaky on its temporary legs. With your cinderblocks in place you can place your first post at one of the corners next to house and c-clamp it to your landing (c-clamping will help hold the post in place while you drill the hole through the post and your landing joist).

Check with a level to make sure your post is standing straight up from both directions. When level you can drill the hole to accept your 1st 5/8 inch bolt. Put your bolt in from the outside, then a washer on the inside followed by your nut. Tighten your nut and repeat this process on your other 3 corners. Recheck that all is level and post are standing straight up in both directions and then install the cross girder across from post to post against house. Some Inspection Departments may not call for a cross girder anywhere in the ramp, some may require it only when you span between post exceeds a certain threshold. A cross girder will definitely add some lateral stability and overall weight bearing capacity. Watch your plans and remember to place your post in the right position. You want your post positioned to accommodate the rails you will add later. If this landing is over 20 inches from the ground you will want to put some cross bracing (see page 5-13). With Top Landing in place, ½ inch below threshold of door, and level both ways, you are ready for your first module.

4. First Module

Make sure to have 2 c-clamps on the ready at the place where the module will meet your Landing. Also have (2) 2x4's with 1 on each side at the lower end of where ramp will end up (these will serve as temporary legs just as you did when setting your Top Landing). Instead of your 2 men at the lower end having to keep holding their end while you decide where the drop will be, this is where an old car jack can come in handy to be used down at the lower end to hold up module until you figure out the height of lower end. Look at the angle you cut on at least 1 end of the module. You should have 1 end at the 5 degree angle if your next part is another module and both ends cut at a 5 degree angle if your next part is a rest landing. Make sure you have the correct end that butts up to your Top Landing. Estimating your drop by eyesight, run your jack down at the lower end to help support the lower end and take some burden off your guys holding the module down there. With module close to its position you can go ahead and drill your 2 holes out (using the 2 holes you have already pre-drilled in the end plate of your module) that will accept your 2 bolts at the top connecting your module with the Top Landing. Get your bolts in with washers and nuts, but leave loose enough for now to accommodate any slight adjustment you may have to may after you determine your actual drop. Now is the time for your carpenter's string, leveling stake and line level. Attach your line at top of point where module meets your Landing. Extend your line out to your stake placed at one of your lower corners. Find where line is level and either mark it or wrap string around stake at this point. If this is an 8 foot module you will measure down your stake 8 inches, or if a 10 foot module you will measure down 10 inches, and likewise with a 12 foot module you measure down 12 inches. This is where the top of your modules lower end will need to be. You should have enough slack in your bolts at top to adjust your lower end to this mark. If using a jack to hold module in place, you can adjust it down close to the mark you need to be at. Attach 1 temporary leg to your stake side of module then level your module across with your 4 foot level and attach another temporary leg to the other side of module. You can now remove the Jack and clear the way for 4 of your men to bring the next module or rest landing over to ramp. With cinderblocks in place you can have 2 men start attaching your 4x4 post beams midway down your module. Find your midway point of module and secure your post upright using the larger c-clamp. Use your level again to make sure post is standing straight up and then drill your hole for the 6 inch bolt that will attach post to module. Then do the same for your post on the other side. Remember (very important) to now go back and tighten the nuts on the 2 bolts at high end of module where it meets the Top Landing.

If next section is another module: With your 1st module in place and the lower end either still supported by its temporary legs and maybe even your midway post now in place, you can proceed with the next module or landing. If another module is next it

is just a matter of joining the 2 ends together and continuing the same slope as you already have going. Initially c-clamping your high end to the module in place and using your jack again to support the lower end until you know you are in line with your slope. You can check this by using your carpenter's line. Tack the end of your line at top of 1st module and pulling line taut from the end at the lower end of your 2nd module starting first with line above your 1st module and coming down with line until it just starts touching the top of your decking boards of the 1st module. Use your leveling stake to hold line in place and raise lower end of module up till it just starts touching your line. It is now perfectly in line with the slope of your 1st module. Tack on a temporary leg on one side at lower end of 2nd module. Check your level crossways; make any adjustments to get level and tack on temporary leg on the other side of 2nd module. You can now drill your hole to join these 2 modules together with 2 4" bolts. The 2 men who are installing post can come right on behind you with the 2 post at top of this second module and 2 posts at the midway point of this 2nd module; and while we are talking about post. The ADA (American Disabilities Act) specs call for the top rail to be between 34 and 37 inches from top of deck. Hopefully somewhere between 34 and 37 inches will work with any existing rails on an existing porch or steps that you are trying to match up with. I would not deviate from this spec very much, especially if you are being inspected by a County Building Inspector.

5. Rest Landing

The Rest Landing is installed much like the Top Landing and Ramp Modules. Your rest landing as discussed before is just as it is named. A landing where the person in the wheelchair or the person pushing the wheelchair will have a flat level place to stop and rest if necessary along their way up or down the ramp. It may also serve as a flat level place where the ramp changes direction such as with the Elbow type of ramp. In a case where it does serve as a change of direction AMA specs call for it to be a minimum of 5 feet x 5 feet, whereas a Rest Landing used in a straight stretch of ramp is the same width as the module 48 inches and at least 5 feet long. Keep this in mind as you are drawing up your plans. So as far as installation it is installed flat and level, same techniques as the modules. The rest landing also kind of serves as a midway anchor since it usually has 4 posts and serves as support of the lower end of the module above it and support for the high end of the module leaving it. Once you have this Landing in place and securely bolted to your first module you can go back and install the midway post for your module(s) coming down from Top Landing and your Under Girder(s) if required.

6. Terminal Module

The Terminal Module is the last module in your ramp that meets the ground. We have built these where we dig out and this module actually ends up flush with the ground at the end point. We have also built these where you have a 3 foot wedge section off the end of the Terminal Module. There is definitely less work using a wedge since you do not have to dig out for the module to end flush. The wedge is absolutely necessary where your End Point is on concrete or asphalt. It may even outlast the module that is buried since it does not have as much direct exposure to the ground.

7. Cutting Your Post

As mentioned elsewhere in this manual, the Americans with Disabilities Act specify that the top rail be between 34 inches and 37 inches from the floor of the ramp. Hopefully to comply with this will still allow you to match up somewhat with whatever rails already existed if you left the existing porch or deck in place. With your rail height determined you are either ready now to cut off the 4x4 post you erected during the construction or you had some of the crew coming down the ramp along with the construction. It is usually best to start with your top landing and with a measuring tape and maybe a small T-Square and pencil, you can mark your let's say your 34 inches from the floor on your post. With a skill saw you can cut your post off. It helps to have another guy holding the top of the post that is getting cut off. Pay attention here to whether the post is cut off level such as the post up against the house where the Top Rail will be setting at level or whether the post is cut at an angle where your Top Rail will start downhill with your first module. Once you have cut the post around the Top Landing you can start down the ramp either by use of running a chalk line from the top of your already cut post where the module meets the Top Landing down to the same height on the first post you get to at the Rest Landing, or by measuring at each post. If measuring each post, on post that are on a sloped place in the ramp you can measure at the high side of your post and then at the low side of your post and this will give you the exact angle the post needs to be cut off. With all your post cut off you can now begin installing your rails.

8. Top Rail

You will of course have a Top Rail. We normally build the Top Rail with a 2x4 on the inside of the post at the top of post. This runs around the Top Landing and then down the ramp. This is capped with a decking board just like you used as the floor of the ramp. This gives the Top Rail a nice clean finished look.

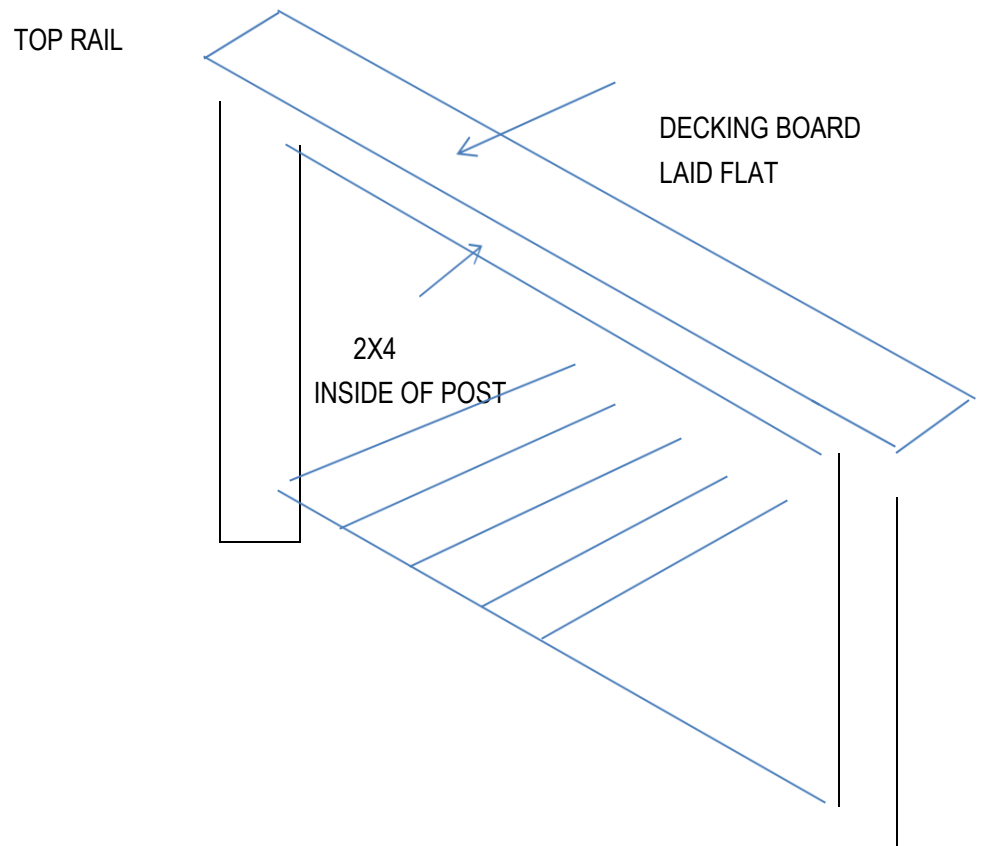

Some counties, such as Nash, require the top rail to be 3 ½ inches or less in width. This means the rail system above may have to be modified. Your county or city may require even a smaller rail. For instance a round rail or as city of Rocky Mount requires the rail to be 1 ½ inches thick and setting off of wall 1 ½ inches. In the city of Rocky Mount we use the same setup as discussed here with the 2x4 on inside of post flush with top of post, then capped with the 5/4 x 6 decking board and then a 2x4 with all 4 edges beveled off mounted on the inside of the 2x4 at top of post. Hopefully this is clear when looking at the sketch on following page.

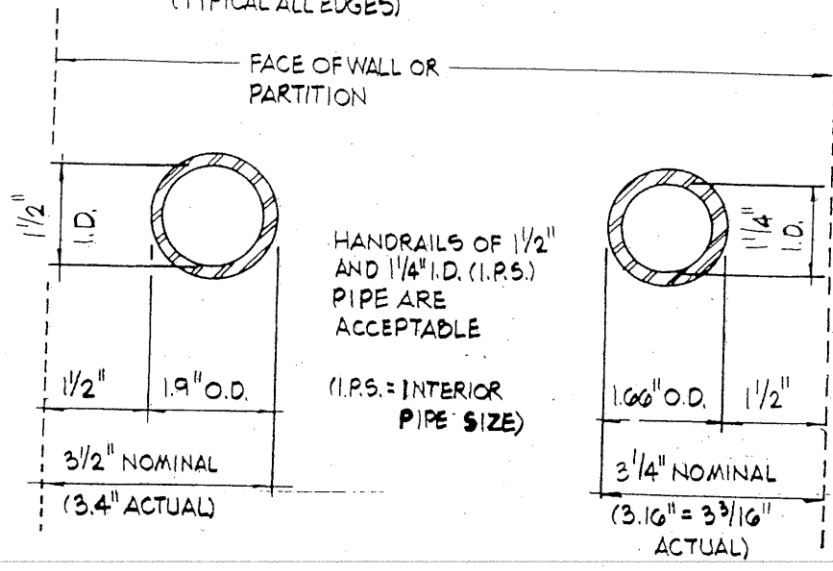
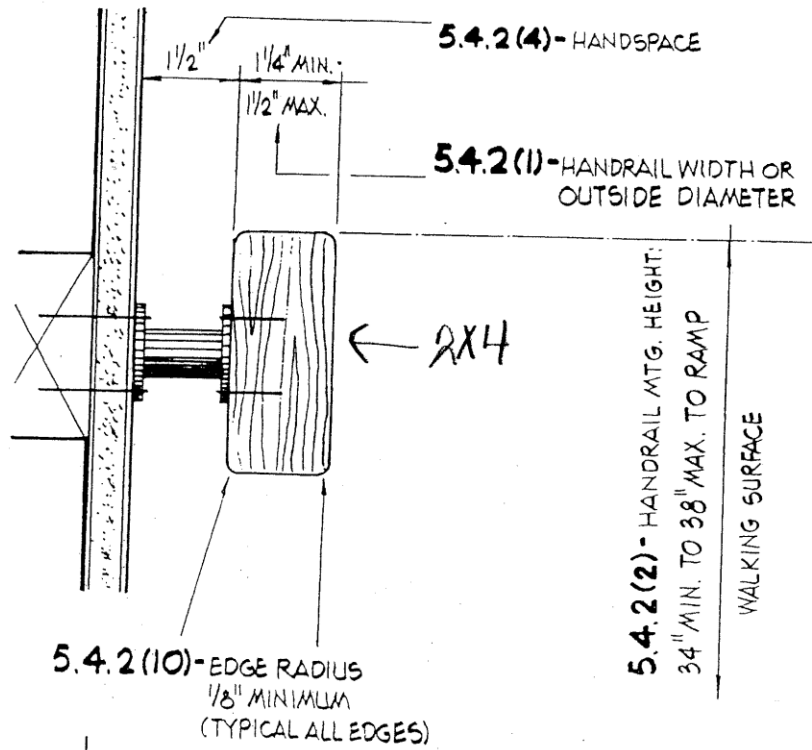

5.4.2 - HANDRAILS

CONTINUOUS HANDRAILS.

IF NOT CONTINUOUS, THEN EXTENSIONS SHALL BE PROVIDED AT THE TOP AND BOTTOM OF EACH RAMP SEGMENT.

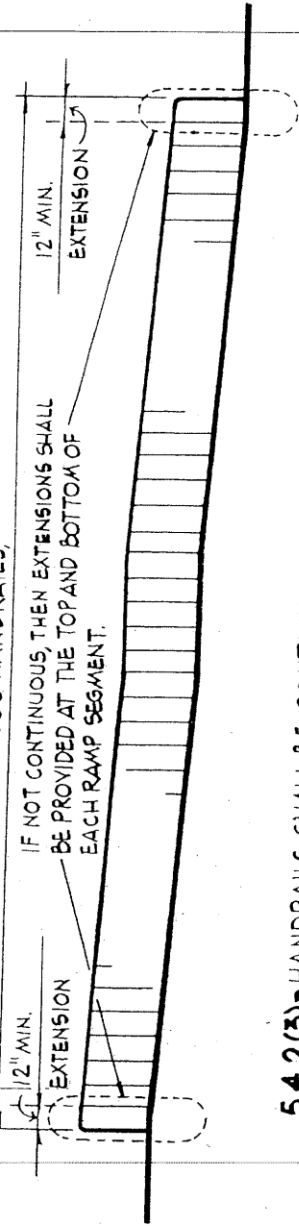

5.4.2(3)- HANDRAILS SHALL BE CONTINUOUS

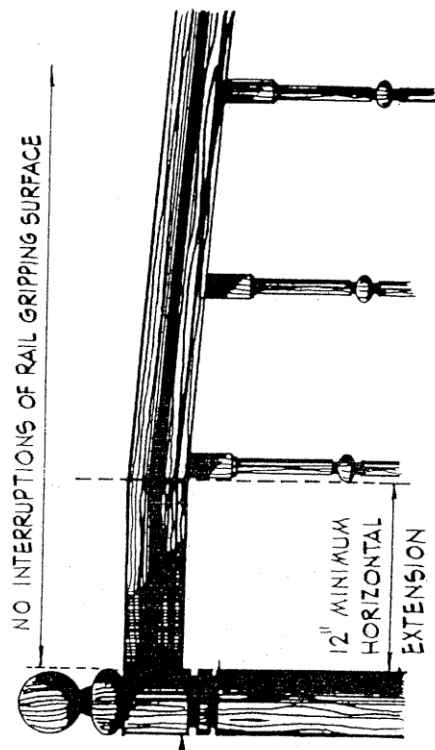

A NEWEL POST MAY BE INSTALLED OUTSIDE THE REQUIRED MINIMUM HORIZONTAL EXTENSION OF THE HANDRAIL.

5.4.2(6)- HANDRAIL GRIPPING SURFACES SHALL BE CONTINUOUS

5.4.2- HANDRAILS

5.4.2(5)- FOR RAMP HAVING A 90° OR 180° TURN THE INSIDE HANDRAIL SHALL BE CONTINUOUS. HORIZONTAL EXTENSIONS ARE NOT REQUIRED. (SEE THE ILLUSTRATIONS FOR 5.3.5.)

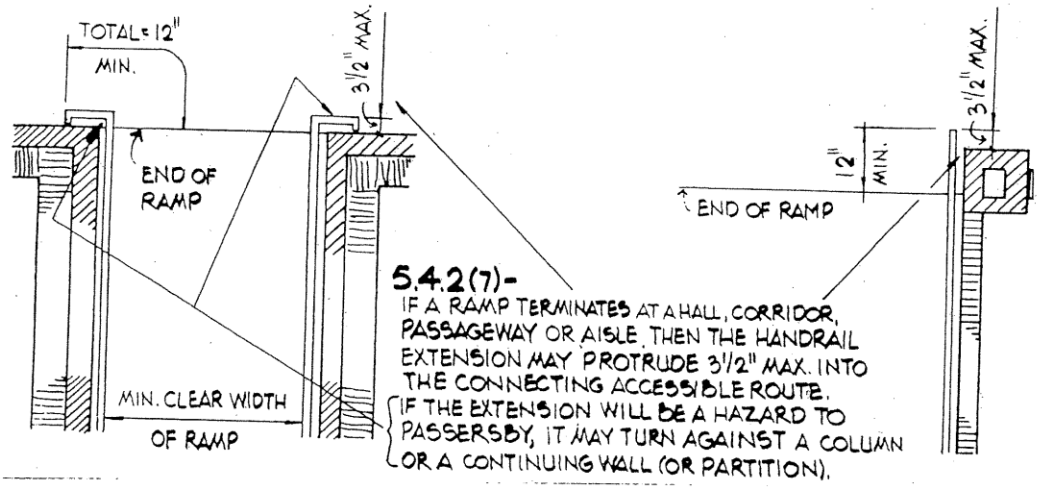
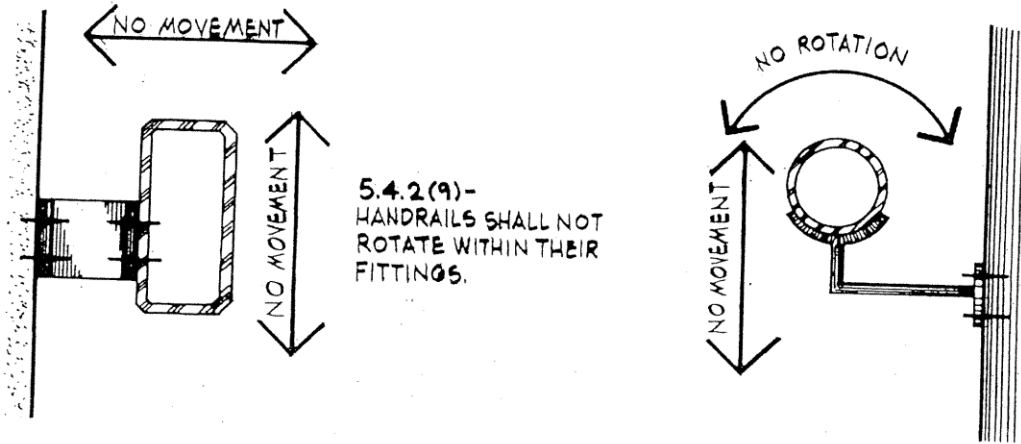

5.4.2- HANDRAILS

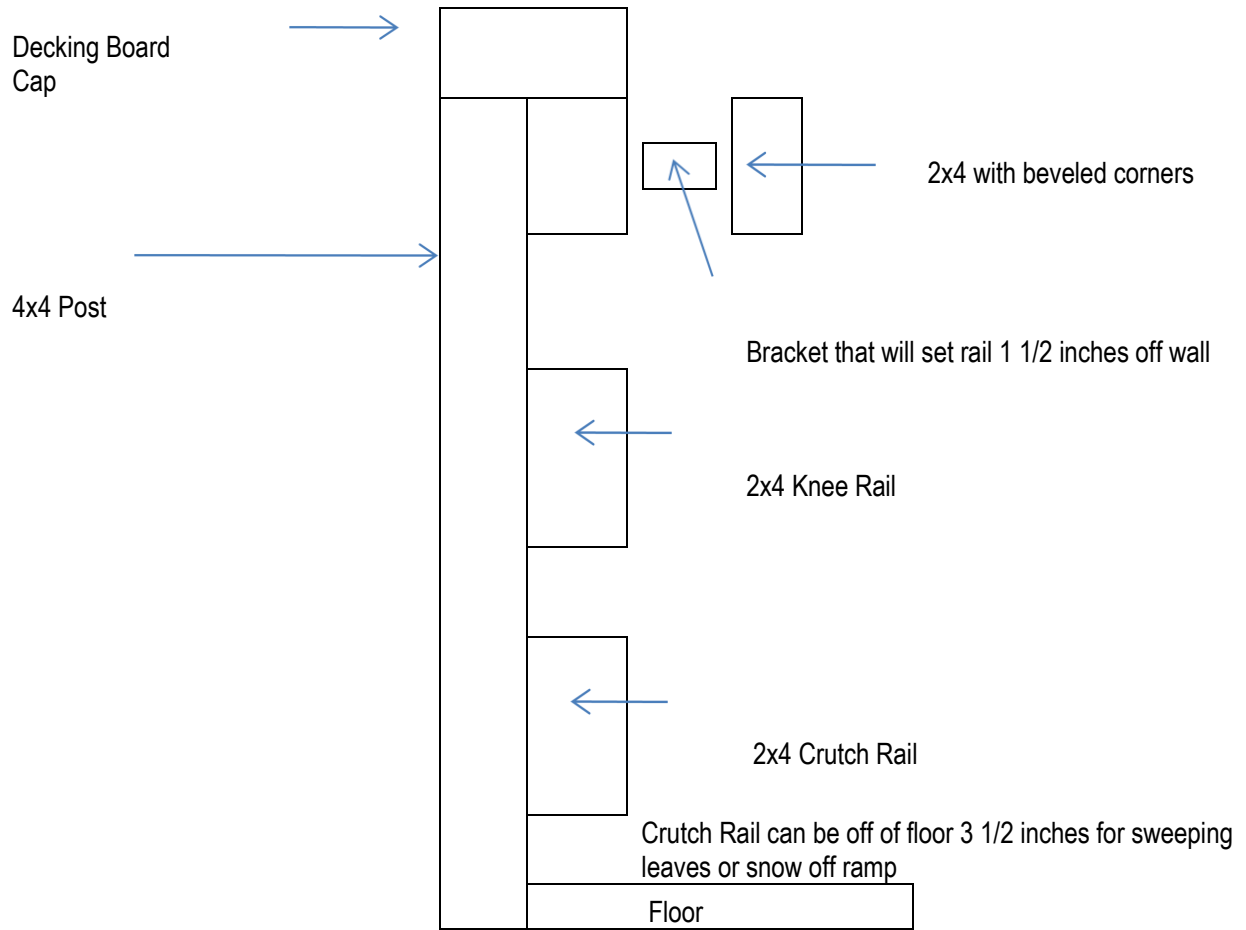

As you see in the picture on previous page, you also have a Knee Rail. This rail is necessary because if your top rail is at say 37 inches from the floor and someone's chair got out of control, they could be tipped out of chair and fall off ramp under the top rail. The Knee Rail as pictured above used 2x4 just as part of the top rail is a 2x4. This might seem to be a bit of over kill, but smaller rails such as 1x3 are too flimsy when you might go 6 feet between posts on a 12 foot module.

The bottom rail or kicker rail can be done in different ways using different size wood. Again in the picture above we used another 2x4 about 3 1/2 inches from floor as your crutch rail. Another way is using 2x2 and cutting blocks of 2x2 for this rail to set on thus putting it 2 inches off of floor, putting your blocks (about 4 inches long) at the base of each post and midway between each post.



In this picture you see an example of the 2x2 kicker or crutch rail sitting on top of 2x2 blocks. This is also a good example of how adding some steps help the other family members and visitors to the home be able to get to the door without having to walk up and down the ramp. This ramp gives a good picture of all the elements of a ramp we have talked about. In this case we had to remove a rotted porch and start with a Top Landing we built, then a 8 foot module leaving the Top Landing down to a Turnaround Landing, then back toward you with another 8 foot module, then a Rest Landing, another 8 foot module and then a wedge Terminal Module which is just out of the picture. Another element that was

added after this picture was a hinged gate at top of steps to prevent the chair from tumbling down the steps when coming out of or going into door.

The rails are one of the elements you will over time adapt to your particular area and experience. We have already evolved from just a 2x4 turned flat on top of post (see picture on previous page) to where we have 2x4 vertically at top of post with 5/4x6 decking capping this off.

5.4.1- HANDRAILS ARE NOT REQUIRED IF THE RAMP CONFORMS TO THE FOLLOWING:

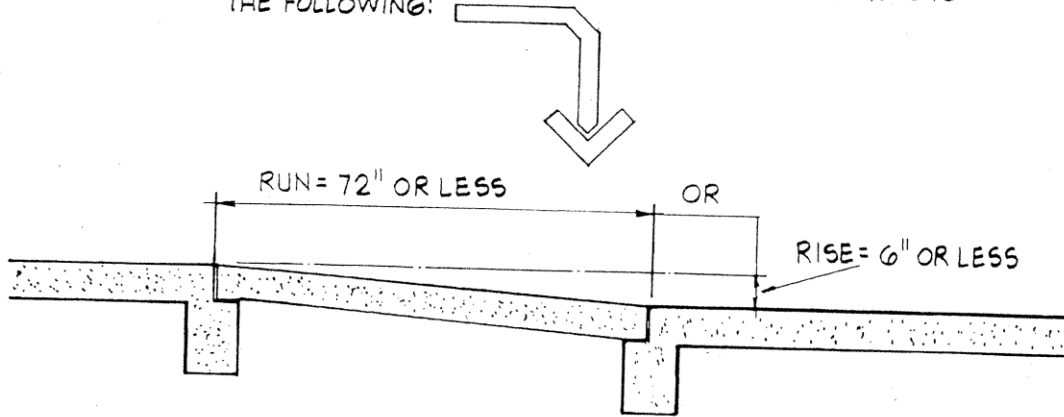

RAMP SLOPE-SEE 5.3.1 AND 5.3.2

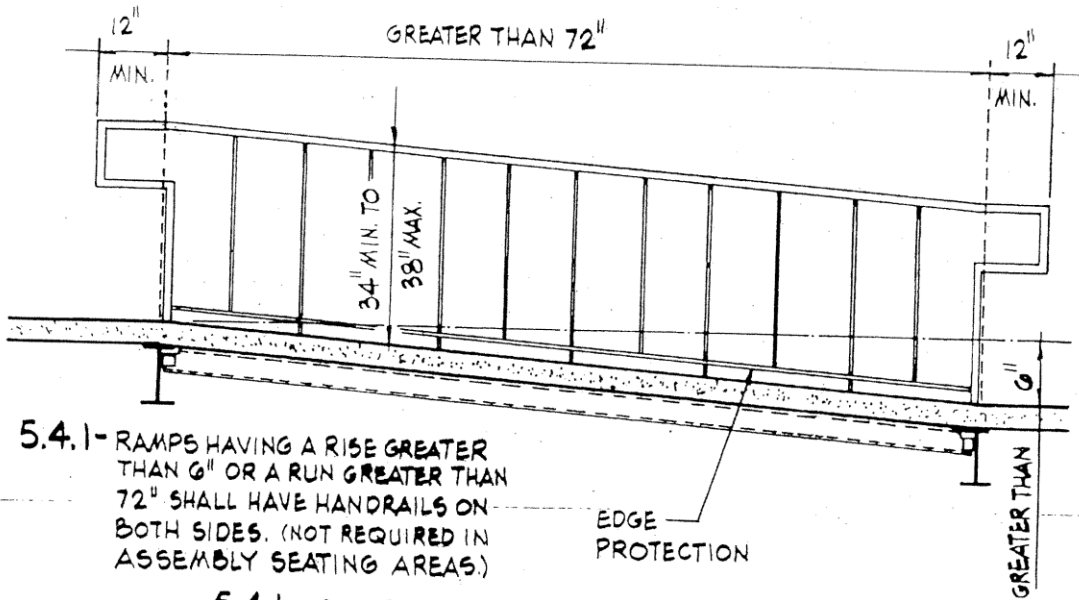

5.4.1- RAMPS HAVING A RISE GREATER THAN 6" OR A RUN GREATER THAN 72" SHALL HAVE HANDRAILS ON BOTH SIDES. (NOT REQUIRED IN ASSEMBLY SEATING AREAS.)

EDGE PROTECTION

5.4.1- RAMPS REQUIRING HANDRAILS

Lateral Bracing

Per building code, you have four options in regard to lateral bracing.

1. If ramp is attached to the structure and is less than 4 feet above finished grade, then no lateral bracing is required.
2. You can use 4x4 knee braces on each post. See description and illustrations on following page.
3. If ramp is freestanding you can provide lateral stability by embedding post in concrete.
4. 2x6 diagonal vertical cross braces in two perpendicular directions. This usually proves to be the easier option given that post are positioned on outside of joist and attaching the 4x4 knee braces with a 5/8" bolt to post and joist could be a challenge.

If you were to do a diagonal set of braces across post up against house and then another set on the post opposite from where your 1st ramp module is attached, you will have met the code as outlined in option 4 above. This can be repeated at any other point down ramp, say at your rest landing if you are still substantially 20" or more above grade. Code requires the 2x6 bracing to be attached to ramp using a 5/8" Hot-Dipped Galvanized bolt at each end.

Note: Materials sheets remind you to order 4 – 8' 2x6's for each set of diagonal bracing your ramp may require.

Section AM107

AM107.1 Floor Decking. Floor decking shall be No.2 grade treated Southern Pine or equivalent. The minimum floor decking thickness shall be as follows:

Joist Spacing	Decking (nominal)
12" o.c.	1" S4S
16" o.c.	1" T&G
19.2" o.c.	1-1/4" S4S
24" - 36" o.c	2" S4S

Section AM108

AM108.1 Post height. Maximum height of Deck support posts as follows:

Post size ^a	Max. Post Height ^{b,c}
4x4	8'-0"
6x6	20'-0"

- a. This table is based on No.2 Southern Pine posts.
- b. From top of footing to bottom of girder
- c. Decks with post heights exceeding these requirements shall be designed by a registered design professional

Section AM109

AM109.1 Deck bracing. Decks shall be braced to provide lateral stability. The following are acceptable means to provide lateral stability.

▶ **AM109.1.1** When the deck floor height is less than 4'-0" above finished grade per Figure AM109 and the deck is attached to the structure in accordance with Section AM104, lateral bracing is not required.

▶ **AM109.1.2** 4x4 wood knee braces may be provided on each column in both directions. The knee braces shall attach to each post at a point not less than 1/3 of the post length from the top of the post, and the braces shall be angled between 45 degrees and 60 degrees from the horizontal. Knee braces shall be bolted to the post and the girder with one 5/8 inch hot dipped galvanized bolt with nut and washer at both ends of the brace per Figure AM109.1

▶ **AM109.1.3** For freestanding decks without knee braces or diagonal bracing, lateral stability may be provided by embedding the post in accordance with Figure AM109.2 and the following:

Post Size	Max. Tributary Area	Max. Post Height	Embedment Depth	Concrete Diameter
4x4	48 SF	4' - 0"	2' - 6"	1' - 0"
6x6	120 SF	6' - 0"	3' - 6"	1' - 8"

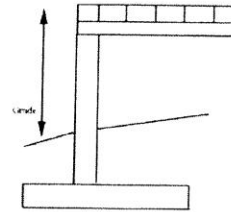

Decked Floor Decking and Right to Support Decking
Figure AM109

Freestanding decks requiring bracing shall be installed in both directions off each post	Decks attached to structure require diagonal bracing only at outside girder line parallel with structure
---	---

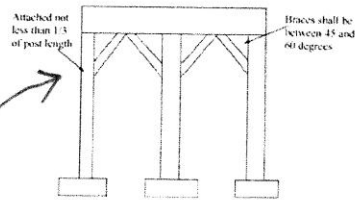

Figure AM109.1

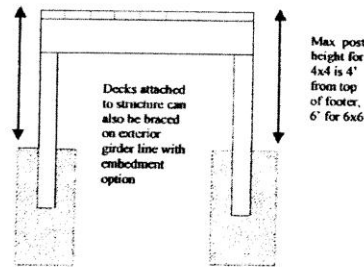

Figure AM109.2

AM109.1.4 2x6 diagonal vertical cross bracing may be provided in two perpendicular directions for freestanding decks or parallel to the structure at the exterior column line of attached decks. The 2x6's shall be attached to the posts with one 5/8 inch hot dipped galvanized bolt with nut and washer at each end of each bracing member per Figure AM109.3.

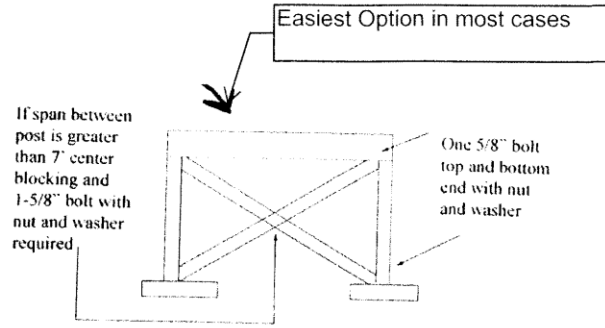

Figure AM109.3

Section AM111
AM111.1 Handrails, Guards and General.
 Deck handrails, guards and general construction shall be per Figure AM111.

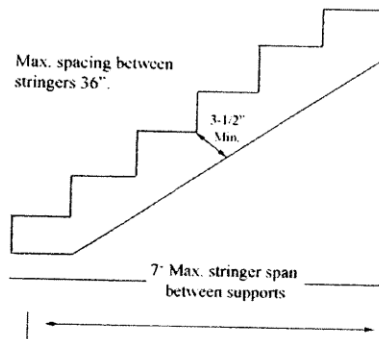

Figure AM110

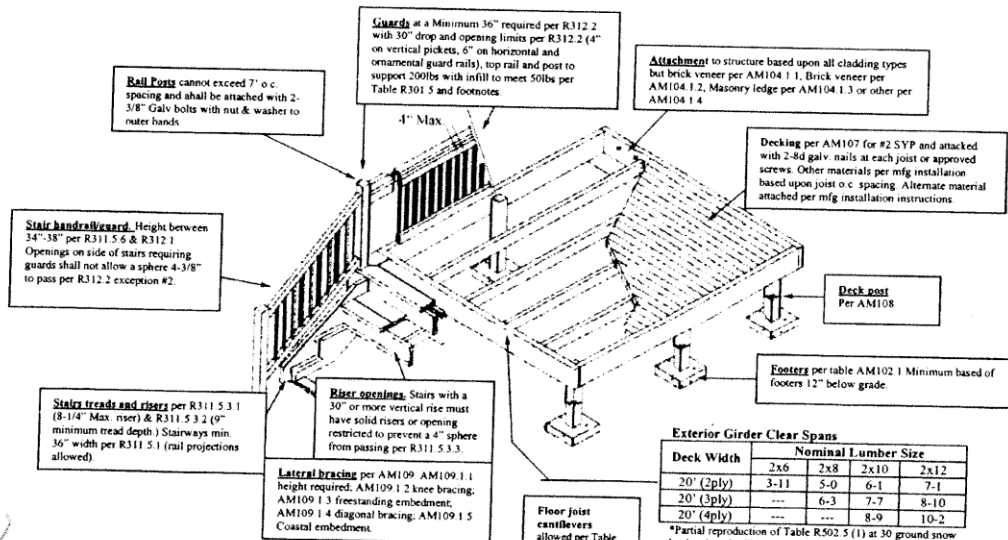

Figure AM111

Deck Width	Nominal Lumber Size			
	2x6	2x8	2x10	2x12
20' (2ply)	3-11	5-0	6-1	7-1
20' (3ply)	---	6-3	7-7	8-10
20' (4ply)	---	---	8-9	10-2

*Partial reproduction of Table R502.5 (1) at 30 ground snow load and roof ceiling and 1 clear span floor Deck width is 20' or less measured in the direction of joists span Splices in plys must break over bearing supports

Appendix A

Definitions

Definitions

1. **Total Drop:** Total Drop is the distance in inches of vertical drop from the bottom of the door or from an existing porch to which the ramp will be attached, to the ground at your end point.
2. **Rest Landing:** A Rest Landing is a flat platform that is a minimum of 5 feet in length somewhere in the middle of a straight run of ramp or as a pivot point when you are changing directions, that gives the person in wheelchair or the person pushing the wheelchair a flat place to rest along the way up or down the ramp. When the Rest Landing is used to change directions such as in an Elbow Style Ramp the Landing must be at a minimum of a 5 feet x 5 in size.
3. **Top Landing:** A flat level platform at door with enough space past door on same side as door handle to allow the person in wheelchair to come up alongside the door and be able to open door while still seated in chair (usually 24 inches if possible).
4. **End Point:** The exact point at which the ramp will meet the ground. This needs to be at a place that is most convenient or desired to get the wheelchair on the ground. Most times this will be at the driveway.
5. **Terminal Module or Wedge:** The Terminal Module is the last module in your ramp that meets the grounds. Usually 3 to 4 feet in length tapered down to nothing at the end point.

Appendix B

Consultation Forms

This section includes forms and illustrations that will be helpful to you on the initial consultation meeting with family. You could take this whole section and copy it and include it in a notebook or whatever you want to use when you go to the home.

It includes:

Checklist - Hopefully to serve as a reminder to you at the site of things to consider.

Ramp configurations - There are 3 basic designs and several different configurations of each design. Included here is several of each design. Hopefully one of these will match what you need for your particular situation and will be helpful in showing the homeowner as you explain what you are proposing building out in their yard.

Cost Estimates - Based on prevailing material cost at time this was written, cost estimates are provided that you can use to quickly come up with a price at the home. This is particularly useful when a homeowner is paying for materials and they need a good faith estimate as to the cost. Even better than trying to estimate with the component cost as listed here, is the Excel worksheet that you can load on your laptop and after making your rough draft plan of how many modules and landings you need, you can drop a few numbers in this worksheet and it gives you a cost estimate. As quick as you can say I need 2- 12 ft. modules, 1- Top Landing, and 1- Rest Landing, you will have a materials list and a cost estimate.

Requirements of Building permit - If you are applying for permit on behalf of homeowner or are assisting them in getting permit, here is a list of information you need to obtain while at the ramp-site. You will need homeowners name and physical address, phone number and other information asked for on permit application.

Permit Application - Hopefully you have obtained applications from the appropriate Building Inspection Department. Be sure to carry a couple of copies with you along with the other things listed here. It will be helpful to you in knowing what questions to ask, or helpful to homeowner if they are applying and you can give them a copy to have already filled out when they visit the inspector's office. Most people are not familiar with the permit process, so anything you can learn about your county or city procedures such as cost, will take away some of the anxiety they may feel about this part of the process. There is some information in the next appendix section for as many counties and cities as could be obtained

Site Plan - The county or city will no doubt want some type of site plan drawing. This drawing needs to show how the home sits on the lot with how many feet off each boundary line it sits. This drawing should show the septic system and where any water lines enter the house. Then on drawing you need to show where ramp will be located, how many feet will it come out from house, which way it will turn, and how many feet it goes in whatever direction

you are going. If you can get this done on your initial visit it will save you a return trip for sure.

COST ESTIMATES

8 FOOT MODULE	\$137.00
10 FOOT MODULE	\$154.00
12 FOOT MODULE	\$166.00
TOP LANDING	\$183.00
REST LANDING	\$133.00
TURNAROUND LANDING	\$230.00

Note: Above estimates can be used if you don't have access to the excel worksheet, when giving your initial estimate.

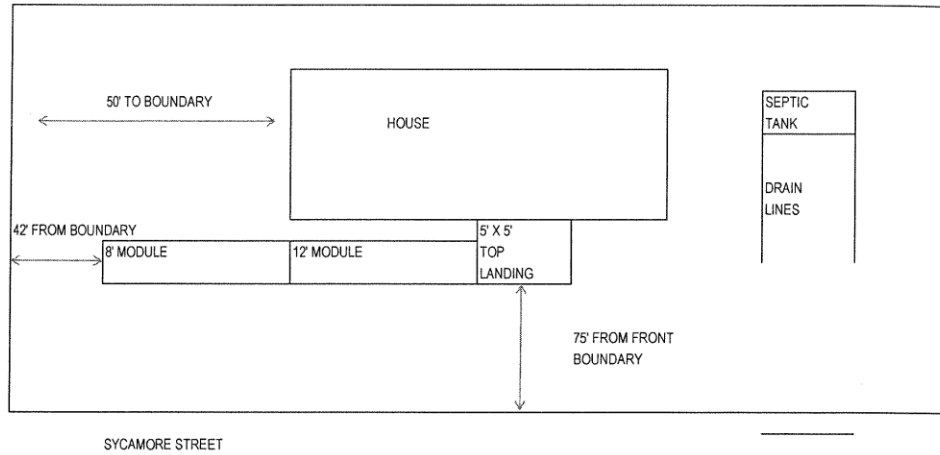

COUNTY BUILDING INSPECTOR WANTS TO KNOW:

- THAT RAMP SETS BACK FROM ANY PROPERTY BOUNDARY BY XXXX NUMBER OF FEET. (THIS MAY VARY FROM COUNTY TO COUNTY)
- THAT RAMP IS NOT ON TOP OF ANY WATER LINE OR ANY PART OF SEPTIC SYSTEM
- HOW RAMP IS CONSTRUCTED AND THE VARIOUS PARTS OF RAMP
- HOW MANY TOTAL SQUARE FEET THE RAMP IS (8' MODULE = 8 LENGTH X 4 WIDTH OR 32 SQUARE FEET. THE PERMIT COST IS PARTLY BASED ON SQUARE FEET IN THE STRUCTURE BEING BUILT.
- HOMEOWNERS NAME, ADDRESS, AND PHONE NUMBER

Appendix C
County/City Regs

THE BUILDING PERMIT PROCESS

This process can differ from County A whose Building and Planning Department says as long as you are a Church group building a ramp for a private homeowner then don't even call our office to County B who says you must apply for a building permit and ramp must not only meet the building code but falls under the Environmental guidelines in that it cannot be built over any water line or any part of the septic system. All of this makes sense since you would not want to tear up a good ramp to repair a leak in a water line. This same county says you must have 2 5/8" bolts in each upright post, the cinder blocks used must be solid instead of hollow, and top handrail must be 3 1/2 inches or less in width. Any portion of ramp that is 21 inches higher than the section of ramp below it or the ground must not have any opening greater than 4 inches. This is to prevent a small child from falling off or getting their body through opening but risking their head getting stuck. You may have to consider the 2x2 pickets mounted on the same 2x4's we use for the rails.

The chart on the following page outlines most of the building specs that a building inspector would be most interested in knowing that your ramp meets or exceeds. Then on the following pages are some of the guidelines per the 1999 North Carolina Accessibility code. The hope is that once they understand that you are building this as a service to someone disabled, you are not in this to make any monetary profit (your reward will await you in Heaven), and that you are building this to code or better, then they will be less rigid in the whole process of awarding the permit and inspecting your work.

BUILDING CODES

	Required per 1999 NC Accessibility Code	We use:
FOOTING:		
ATTACHED TO BUILDING	5/8" Hot-Dipped Galvanized bolt every 42"	5/8" bolt every 24"
FREE STANDING	8X16 Drystack Precast Solid Block per 4x4 Post	8x16 Drystack solid post footing block per 4x4 post
SUPPORT POST:		
HEIGHT/SPACING	4X4 Up to 8 feet 6x6 Up to 20 feet	4x4 Up to 8 feet-every 24 sq. ft. n/a
ATTACHED TO JOIST	2- 5/8" Hot-Dipped Galvanized Bolt per post	2-5/8" Hot-Dipped Galvanized Bolts per post
LATERAL BRACING:		
	In concrete-N/R on post up to 48"	
FREE STANDING	2x6 diagonal verical cross-bracing in 2 perpendicular directions attached to post with 5/8" bolts at each end	At any place exceeding 20" from ground we use 2x6 diagonal bracing in 2 directions at each corner attached to post with 5/8" bolts at each end
FLOOR THICKNESS:		
	If joist on 24" center- 1 1/4 " decking required	Modules on 24" center- 1 1/4 decking used Top landing on 20"center-1 1/4" decking used Turn-around landing on 24" center- 1 1/4" decking used
SLOPE:		
	1:12 for Exterior Ramp	1:12 or less
CLEAR WIDTH:		
	36" Minimum	48" less 6" that rail extends inward or 42" clear
REST LANDING:		
	1:12 slope every 30 ft of horizontal run 60" length x same width as ramp	1:12 slope rest landing at 20 ft. maximum, usually have 1 every 12 feet. 60" length x same width as ramp
TOP LANDING:		
	60" X 60" Clear space	60" x 60" Clear space minimum
TRANSITION LANDING:		
	60" X 60" Clear space	60" x 60" Clear space
TURN-AROUND LANDING:		
	60" X Width of both ramps	60" X Width of both ramps
RAIL HEIGHT:		
	34" TO 38"MAX from walking surface	34" to 38" Max from walking surface
RAIL SIZE:		
	1 1/4" to 1 1/2" max. with 1/8" radius corners 1 1/2" outset from wall	1 1/2" with 1/8" radius corners 1 1/2" outset from wall